



Leiden University
Medical Center

IEEE Milestone Award “String Galvanometer”

The Heritage and the Promise of
Electrocardiography and Electrophysiology

Proceedings of a symposium held on April 8, 2022

Editors:

Wim van Etten

Cees A. Swenne

Enno T. van der Velde

Leiden, Boerhaave Continuing Medical Education, 2022

IEEE Milestone Award “String Galvanometer”

The Heritage and the Promise of Electrocardiography and Electrophysiology

Editors:

Wim van Etten

Cees A. Swenne

Enno T. van der Velde

Publisher: Boerhaave Continuing Medical Education, Leiden

© 2022 Copyright the authors; sharing of this e-book with others is allowed, editing of any part of its contents is not permitted.

ISBN 978 90 67677 82 0

Contents

<u>Introduction</u>	1
<i>Editors: Wim van Etten, Cees A. Swenne, Enno T. van der Velde</i>	
<u>IEEE at a Glance</u>	3
<i>Wim van Etten</i>	
<u>Physics and Engineering Aspects of the String Galvanometer</u>	9
<i>Paul Regtien</i>	
<u>Bad Vibrations - The Quarrel between Willem Einthoven and Heike Kamerlingh Onnes</u>	23
<i>Dirk van Delft</i>	
<u>A Selection of the Photographic Glass Recordings by Einthoven and Coworkers</u>	33
<i>Norbert M. van Hemel, Pascal F.H.M. van Dessel and Jacques M.T. de Bakker</i>	
<u>Einthoven Lived Here</u>	49
<i>Peter van der Geer</i>	
<u>The Bright Future of Clinical Technology and Technical Medicine</u>	55
<i>Roderick W.C. Scherptong</i>	
<u>Electrocardiographic Imaging: History, Applications, and Future Perspectives</u>	65
<i>Job Stoks and Matthijs Cluitmans</i>	

To cite one of the articles in this book, use the following format (the text with brackets to be adapted):

[Author name(s)] , ["Title"], in: *IEEE Milestone Award 'String Galvanometer': The Heritage and the Promise of Electrocardiography and Electrophysiology*, edited by W. van Etten, C.A. Swenne, and E.T. van der Velde, [start page]-[end page]. Leiden, NL: Boerhaave Continuing Medical Education, 2022. ISBN 978 90 67677 82 0.

Introduction

On April 8, 2022, the Cardiology Department of the Leiden University Medical Center and the Institute of Electrical and Electronics Engineers (IEEE) organized a symposium entitled:

*The IEEE Milestone Award "String Galvanometer"
The Heritage and the Promise of Electrocardiography and Electrophysiology*

This symposium was organized around the dedication of a prestigious IEEE Milestone Award to the development of the string galvanometer by Willem Einthoven (1860-1927).

A number of renowned authors and scientists related to the topic of the symposium were invited to give a presentation on their contribution to this field. In addition, they were asked to contribute to this Symposium Book with an article covering their presentation on the symposium.

Typically, Willem Einthoven's work was multidisciplinary. Regarding the string galvanometer, he blended mechanical engineering, electrical engineering, physics, and mathematics for its development. Being able to record physiological signals of unprecedented technical quality with this string galvanometer, he blended biology, physiology, and medicine to design and interpret experiments and observations during the decades to follow, for which he received the Nobel prize in Physiology or Medicine in 1924. In harmony with this historical background, the presentations during the symposium and, consequently, the articles in this Symposium Book stem from multiple disciplines.

This Symposium Book was produced without commercial interest; it is available for free as a PDF file. This file can freely be distributed in its original form; editing is not permitted. The copyrights rest with the authors of the articles. We are very grateful to the authors who contributed to this Symposium Book and to Boerhaave Continuing Medical Education, organizer of the symposium, and publisher of this book.

The concluding presentation of the symposium was given by professor Katja Zeppenfeld. Professor Zeppenfeld gave an in-depth overview of the present status of the diagnosis and treatment of ventricular arrhythmias. She was invited to give this presentation as the "Einthoven Lecture," a long tradition in the Cardiology Department of the Leiden University Medical Center¹. This presentation could be followed online by the attendants of the

¹<https://www.hartlongcentrum.nl/over-ons/geschiedenis/einthoven-lectures/>

ISCE (International Society for Computerized Electrocardiography) 2022 meeting, held in Henderson, Nevada, USA. Due to its different character this Einthoven Lecture has not been included in the symposium book.

We hope that readers from various disciplines will find interesting and useful articles among the ones that have been collected in this book.

The Editors:

Wim van Etten,
Emeritus Professor Telecommunication Engineering,
University of Twente, the Netherlands

Cees A. Swenne and Enno T. van der Velde,
Cardiology Department,
Leiden University Medical Center, the Netherlands

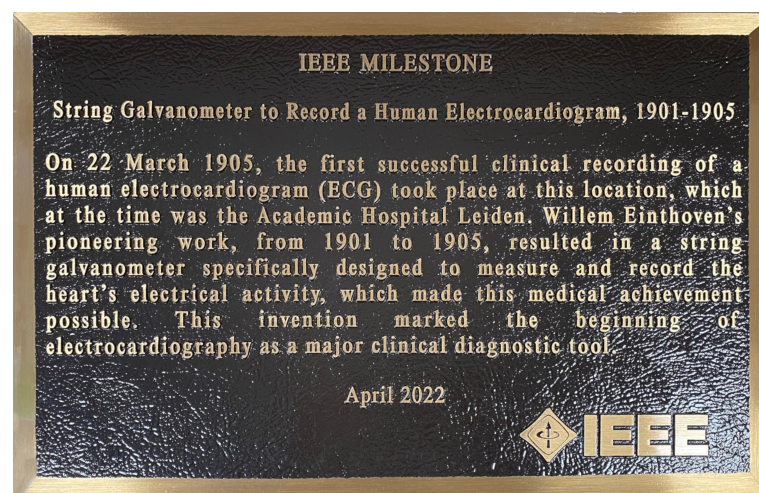

The IEEE Milestone Award plaque

IEEE at a Glance

Wim van Etten

Emeritus Professor Telecommunication Engineering

University of Twente, the Netherlands

Abstract

The Institute of Electrical and Electronic Engineers, for short IEEE¹, is the largest organization for technical professionals. Its membership is spread all over the world. The main goal of this institute is *Advancing Technology for Humanity*. IEEE and its members inspire a global community through its highly cited publications, conferences, technology standards, and professional and educational activities. Next the global presence of IEEE is shown,

The organization of IEEE is described by defining the several operational units. The importance of IEEE is shown by presenting a few characteristic data. Next the focus is on the IEEE in the Benelux and on Milestones. The IEEE Milestones program honors significant technical achievements in all areas associated with IEEE. Milestones recognize the technological innovation and excellence for the benefit of humanity found in unique products, services, seminal papers and patents.

1 IEEE worldwide

With more than 422,000 members, IEEE is the largest technical professional organization. It is dedicated to *Advancing Technology for the Benefit of Humanity*. The long name of the organization is *Institute of Electrical and Electronics Engineers*. The IEEE was established in 1963 as a merger of two institutes of electrical engineers. The first one is the AIEE (American Institute of Electrical Engineers). This organization was erected in 1884 and quite some famous electrical engineers chaired it, such as Edison, Bell and Tesla. The second merging institute was the IRE (Institute of Radio Engineers), which was erected in 1912. It was chaired by famous engineers as well, to mention: Lee de Forest, Terman and Hewlett. As the name suggests, the AIEE was mainly focused to US membership, whereas the IRE was rather worldwide organized. By this merger a very powerful and worldwide institute arose.

¹For further information see web site www.ieee.org

In order to manage this worldwide, large institute efficiently it is divided in geographical regions (see Figure 1):

- Region 1 to Region 6: US
- Region 7: Canada
- Region 8: Europe, Iceland, Greenland, Russia, Middle East and Africa
- Region 9: South America
- Region 10: Far East

IEEE: Diverse Membership

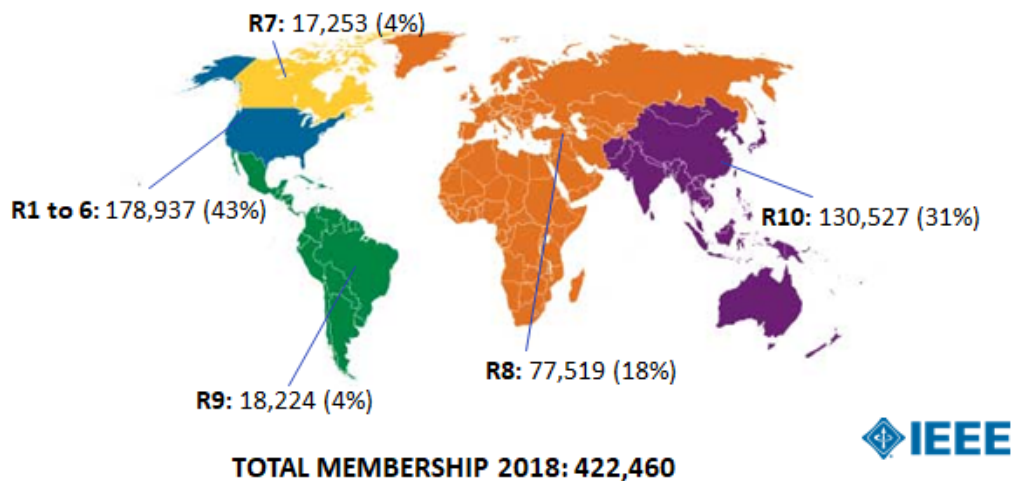

Figure 1: Geographical regions of IEEE, including membership

It will be clear that Region 8 is by far the most extensive region from a geographical point of view. However, this is not the case as to membership. This is obvious when realizing that it comprises many developing countries and sparsely populated countries as Iceland and Greenland.

Apart from this geographical grouping additional organizational units (OU's) have been defined:

Region: organizational unit that represents IEEE in territory

Section: organizational unit that covers part of a region (one or a few countries)

Society: community for exchange of technical information among members in a specific discipline

Chapter: technical subunit of region or section

Student branch: organizational unit of student members from a particular college, university or technical institute

The Chapters are centered around a technical area of interest (in accordance with one or a few Societies) and Student Branches by geographic location. They organize local professional and technical activities. The administration runs along the line of the Region and the Section.

2 Activities

With its over 422,000 membership in more than 160 countries the IEEE has a global reach and provides the following facilities to its members:

- Societies provide benefits to members within specialized fields of interest: society peer-reviewed and top-cited publications
- More than 1900 annual conferences
- More than 1300 active standards
- More than 4 million technical documents
- Significant discounts on society publications, conference registration, and other products
- An expansive professional network of worldwide technology experts in many fields of interest
- Continuing education and certification

The global reach is further achieved by IEEE presence in different parts of the world by means of offices at: both US East and West Coast, Europe (Brussels and Vienna), China (Shenzhen and Beijing), India (Bangalore), Japan (Tokyo) and Singapore.

According to its mission the institute developed a Code of Ethics. IEEE aims its members to:

- Foster awareness on ethical issues
- Promote ethical behavior among those working within IEEE fields of interest
- Create a world in which engineers and scientists are respected for exemplary ethical behavior

Besides, the IEEE is involved in global humanitarian efforts. The IEEE Humanitarian Activities Committee (HAC) has the task to support the board-endorsed vision of IEEE volunteers around the world carrying out and/or supporting impactful humanitarian activities at the local level; i.e. "feet on the ground."

2.1 The History Committee

The History Committee, a committee of the IEEE Board of Directors, is responsible for promoting the collection, writing, and dissemination of historical information in the fields covered by IEEE technical and professional activities, as well as historical information about IEEE and its predecessor organizations. It provides assistance to all major organizational units, works with institutions of a public nature when helpful information is requested and

can be secured, and provides information and recommendations to the IEEE Board of Directors when appropriate. The History Committee members also review nominations for IEEE Milestones and scholarship applications.

2.2 The Milestone Program

The IEEE Milestones program honors significant technical achievements in all areas associated with IEEE. It is a program of the IEEE History Committee, administered through the IEEE History Center. Milestones recognize the technological innovation and excellence for the benefit of humanity found in unique products, services, seminal papers and patents. Milestones are proposed by any IEEE member, and are sponsored by an IEEE Organizational Unit (OU) such as an IEEE section, society, chapter or student branch. After recommendation by the IEEE History Committee and approval by the IEEE Board of Directors, a bronze plaque commemorating the achievement is placed at an appropriate site with an accompanying dedication ceremony.

IEEE established the Milestones Program in 1983 in conjunction with the 1984 Centennial Celebration to recognize the achievements of the Century of Giants who formed the profession and technologies represented by IEEE.

Each milestone recognizes a significant technical achievement that occurred at least twenty-five years ago in an area of technology represented in IEEE and having at least regional impact. More than two hundred IEEE Milestones have been approved and dedicated around the world. The milestone for the String Galvanometer is number 222 in the row.

3 The IEEE Benelux Section

The IEEE Benelux Section was erected in 1959, together with the Italian Section it was the first section in Europe. At the occasion of its fiftieth anniversary, the section banner was presented by the IEEE President John Vig (see Figure 2).



Figure 2: John Vig (left), 2009 IEEE President, presents section banners to both the Benelux and Italian section.

The section includes:

- > 3500 members, incl. 740 student members
- 19 chapters, 8 student branches
- 3 Affinity Groups (Women in Engineering, Life Members and Young Professionals)

The section is proud to have four Milestone Awards in its territory today, namely:

- *Compact Disc Audio Player, 1979*. Dedicated March 2009

The plaque of this Milestone has been placed at the Philips Research Laboratory at Eindhoven (see Fig. 3).

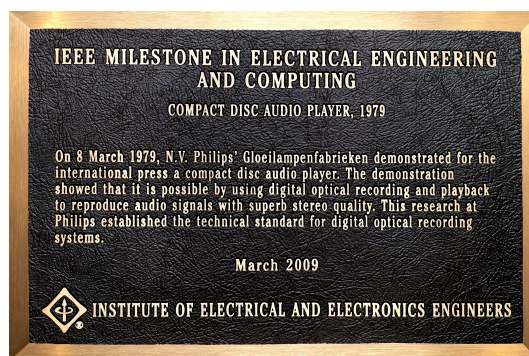

Figure 3: The plaque of the CD Milestone

- *Discovery of Superconductivity, 1911*. Dedicated April 2011

The plaque of this Milestone is at the University of Leiden, Faculty of Law building (see Fig. 4).

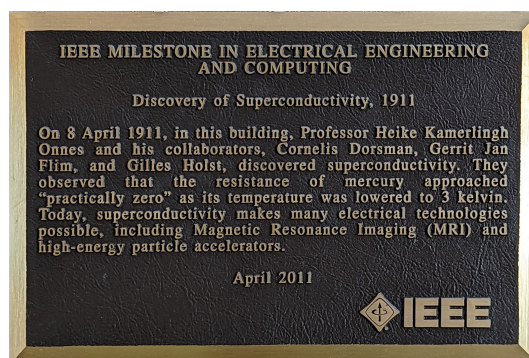

Figure 4: The plaque of the Superconductivity Milestone

- *WaveLAN, Precursor of Wi-Fi, 1987*. Dedicated October 2019

The plaque of this Milestone has been placed at the entrance of the town hall at Nieuwegein (see Fig. 5).

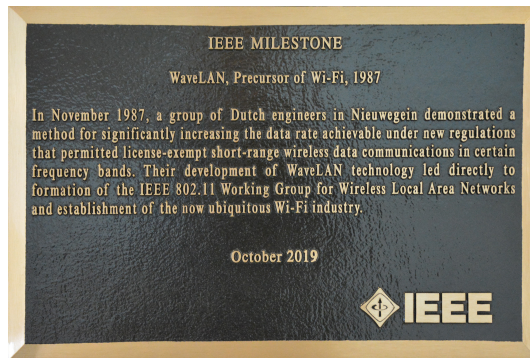

Figure 5: The plaque of the Wi-Fi Milestone

- *String Galvanometer to record a human electrocardiogram*, 1905. Dedicated April 2022

The plaque of this Milestone will be placed in the entrance hall of the Leiden University Medical Center. A picture of the plaque is presented in the Introduction of this Symposium Book.

At this moment the IEEE Benelux Section has still one more milestone application pending.

Physics and Engineering Aspects of the String Galvanometer

Paul Regtien

Emeritus Professor in Measurement and Instrumentation

University of Twente, the Netherlands

Abstract

In this article, the development of Einthoven's string galvanometer is reviewed in historical perspective. The article starts with an overview of earlier attempts to measure the electrical heart activity. The next section explains the basic construction of the string galvanometer. It includes the physical basis of the measurement principle, the consequences for the design, the motivation of the choice for a thin wire as a sensing element to measure the small currents delivered by the heart, and the necessary steps to achieve a sufficiently high sensitivity. A further section describes the additional instrumentation for the visualization of the final electrocardiogram. The result was a very heavy but effective instrument able, for the first time, to register an ECG suitable for diagnostic purposes. The last section briefly discusses the commercialization of the string galvanometer until it was finally replaced by an all-electronic measurement system.

1 Introduction

Present electrocardiographs measure the potential differences between a number of electrodes placed at particular places on the skin. These voltages are registered and combined in a specific way by an electronic signal processor. The result is rendered as a time-amplitude plot (the electrocardiogram, ECG) on paper, on a monitor, and/or as a digital file. It gives detailed information about the condition of the heart and is suitable for diagnosis. The process is relatively simple, takes only a few minutes, and can be executed without discomfort for the patient.

The difference between a modern electrocardiograph and the string galvanometer developed and used by Willem Einthoven at the beginning of the 20th century is enormous: by then it was a large, heavy machine (600 pounds), operational by experts only, a long processing time, and an embarrassing act for the patient. Notwithstanding this all, the string galvanometer paved the way to a successful development of electrocardiology over a period

of 120 years. But what were the possibilities for Einthoven to create an electrocardiogram suitable for diagnosis; what was the reason for his preference to design such a complicated electro-mechanical sensing system; what were the technical consequences of this choice; how did he cope with the technical difficulties?

To find an answer to such questions, it is necessary to get acquainted with some technical and theoretical developments in science during the centuries preceding the realization of the string galvanometer on which Einthoven based his ideas to achieve his goals.

2 Early electrocardiography

From the time one understood that the pumping mechanism of the heart is activated by electrical pulses generated by the body itself, many attempts have been undertaken to measure and register these signals, preferably in a non-invasive way.

Some important discoveries and innovations done before the year 1901 and that were determinative for the later development of electrocardiographs are listed here below. An extensive overview is given in [1, 2].

Table 1: Some early observations and innovations decisive for the development of electrocardiography

1780/91	Luigi Galvani	let muscles of a dead frog's leg move by an electrical stimulus
1820	Hans Chr. Ørsted	observed the movement of a compass needle near a current carrying wire
1821	Johann Schweigger	built the first galvanometer, named after Luigi Galvani
1824	William Sturgeon	made the first electromagnet
1856	A. von Kölliker and H. Müller	showed that an electric current accompanied the contraction of a frog's heart, using a galvanometer
1873	Gabriel Lippmann	developed a sensitive capillary electrometer
1882	J.-A. d'Arsonval	developed a galvanometer with a permanent magnet
1887	August D. Waller	created the first practical ECG machine with the capillary electrometer

The observation of the moving compass needle by Ørsted demonstrated the existence of a connection between electric current, magnetism, force and movement. A wire carrying an electrical current is surrounded by a magnetic field of which the field lines (lines of equal magnetic strength) form concentric circles around this wire, and with a strength that falls linearly with the distance to the wire. Almost immediately after Ørsted's discovery, Schweigger recognized this as a possibility for a method to measure electrical currents and created the first primitive galvanometer. He wrapped the wire spirally around the compass needle; each

turn contributes to the magnetic field in the center of the coil, thus multiplying the magnetic field strength by the number of turns.

Not much later, in 1824, William Sturgeon invented the electromagnet. By inserting an iron core in the coil center, the magnetic field is increased by a factor μ_r , the relative permeability of the core material, which can be as large as 1000.

The performance of galvanometers was gradually improved. In the version of d'Arsonval and others (1882), the current to be measured is led through a small rotating electromagnet, placed in the magnetic field of a permanent magnet. The resulting rotation of the coil is counteracted by a spring until equilibrium. A pointer connected to the coil indicates the value of the current through the coil. According to this principle, these instruments were called moving coil galvanometers. The lowest measurable current of the most sensitive version was about $0.1 \mu\text{A}$ [3], whereas for a high-quality ECG a much lower detection limit was required. Moreover, due to the mass of the coil (with core) the instrument could not follow the fast fluctuations of the heart signal.

A few years earlier, in 1873, Gabriel Lippmann used another method to measure small electric pulses: the capillary electrometer. It consists of a capillary tube, partly filled with mercury. An electric pulse applied to the mercury reservoir changes the surface tension of the mercury, which then rises in the capillary tube.

Augustus Desiré Waller used this device to build the first electrocardiograph around 1887, and demonstrated his electrocardiograms of his dog. In 1889 the first ECG of a human heart was recorded by this instrument. Einthoven, inspired by this result, used this instrument for about seven years (1883-1900) for his early studies of ECGs, together with Waller. Although he was able to reconstruct a more precise ECG from the variations in the height of the mercury meniscus of the capillary electrometer, the handling of the instrument was very complicated and time consuming. Nevertheless, during this period he defined the PQRST notation for the positive and negative waves in the ECG [2, 4], still in use nowadays.

Because the capillary electrometer did not give a satisfactory ECG, and the galvanometer was too slow and had insufficient sensitivity, Einthoven looked for a better method to obtain an ECG suitable for diagnostic purposes.

3 Construction of the string galvanometer

Despite many attempts to increase the sensitivity of galvanometers to measure heart activity, by the end of the 19th century, no suitable instruments existed. Therefore, Einthoven returned to the observation by Ørsted in 1820: the movement of a magnetized compass needle nearby a current carrying wire. Similar to the existing galvanometers, he exchanged the position of the wire and the compass needle: a static magnetic field and a movable wire. After all: the physical laws also apply to the inverse situation. The reason to choose a single, straight wire is obvious: a wire (the string) has a much lower mass compared to a coil and hence less force

is required to let it move. Therefore, this approach may result in a shorter response time than the moving coil galvanometer. On the other hand, the sensitivity could be less because of the absence of a material with high permeability as used in the galvanometer.

The basic equations underlying the new method are, in simplified form:

Lorentz force: force on a moving charge in a magnetic field: $\mathbf{F} = q(\mathbf{v} \times \mathbf{B})$

Force on a straight wire with length L conducting a current I : $\mathbf{F} = I(\mathbf{L} \times \mathbf{B})$

Here, \mathbf{F} , \mathbf{v} , \mathbf{L} , and \mathbf{B} are vectors, representing force, velocity (of a charge carrier), the length of the current-carrying wire in the magnetic field, and the magnetic induction¹, respectively. The notation $\mathbf{c} = \mathbf{a} \times \mathbf{b}$ is the cross product of vectors \mathbf{a} and \mathbf{b} , and describes a vector \mathbf{c} that is perpendicular to both \mathbf{a} and \mathbf{b} . A wire, carrying the current to be measured, and suspended in a static magnetic field, will deflect in proportion to the current under the influence of the force. Maximum sensitivity is achieved when:

- the magnetic field \mathbf{B} has maximal strength where the wire resides;
- the wire has maximal length and minimal thickness, to achieve sufficient deflection;
- the electrical resistance of the wire is as small as possible.

Moreover, the wire must react quickly to changes in the current due to the heart's activity but should not show resonance or vibrations when activated. Finally, it must be accessible for observation, in order to allow registration of its deflection. According to the second equation above, the direction of the force and hence the deflection of the wire is perpendicular to both the direction of the current and the magnetic field.

Some of these requirements are conflicting. For instance: the longer and thinner the wire, the higher its electrical resistance, and hence the smaller the current through it. A wire that satisfies this combination of requirements will hardly be found, and thus should be newly made for this application. A sophisticated mechanical design is required to satisfy all other requirements.

3.1 The magnetic field

A strong magnetic field can only be obtained by electromagnets supplied with large currents. However, heat production in the coils is proportional to the square of the current. It turned out that forced cooling is necessary to avoid overheating and to minimize temperature influence on the measurement results.

Given a magnetizing current, a stronger magnetic field close to the wire can be achieved using flux concentration. This principle is illustrated in Figure 1. It shows lines of constant

¹ B is magnetic induction, H is magnetic field strength: $B = \mu_0\mu_r H$. In this text both quantities are named magnetic field for brevity.

magnetic flux of a permanent magnet. At the left side, the magnetic field strength decreases sharply outside the magnet. At the right-hand side, a piece of material with high permeability (μ_r) is placed, creating a path of low magnetic resistance. Hence field lines originating from the magnet are concentrated in the space just at this end of the magnet, resulting in a higher magnetic field strength there.

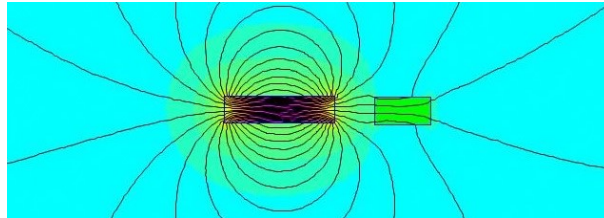

Figure 1: Effect of flux concentration.

An even better result is obtained with two electromagnets with facing north pole and south pole. Einthoven used two electromagnets, and firmly connected separate pole shoes P and P_1 at their ends, as shown in the top view in Figure 2a. The tapered shapes of the pole shoes concentrate the magnetic field between the two electromagnets to the small space between the ends. The current-carrying wire (the dot in this figure) is positioned just in that area. The core material of the magnets in the prototype is iron. Einthoven reported a magnetic field strength of 23000 Gauss (2.3 T) at a magnetizing current of 2.7 A [5], substantially larger than the earth magnetic field (25 to 65 μT or 0.25 to 0.65 Gauss)².

3.2 The string

The direction of the wire (from now on the string) denoted by the dot in Fig 2a is perpendicular to the paper. In Figure 2b the direction of the magnetic field \mathbf{B} and the force \mathbf{F} on the string is drawn. According to the cross product in the second equation above the force vector points downwards in vertical direction, when the current flows from top to bottom.

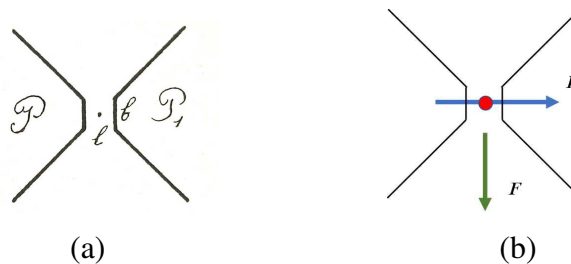

Figure 2: Top view of the pole shoes P and P_1 ; l is the distance between the pole shoes: $l = 2 \text{ mm}$, $b = 2 \text{ mm}$ [5] (a); F is perpendicular to both B and the wire (b).

²The old unit for magnetic field strength is Gauss; the present SI-unit is Tesla; 1 Gauss (Gs) = 0.0001 Tesla (T) = 100 μT .

Since the direction of \mathbf{F} is perpendicular to \mathbf{B} and perpendicular to the direction of the current in the string, the deflection of the latter can only be observed in the direction of \mathbf{B} . However, this is blocked by the pole shoes of the magnet and the fixation of the string. The solution is a hole through both pole shoes. Obviously, this will reduce the strength of the magnetic field somewhat. Since the string is fixed at both ends, but the force acts over its entire length between the pole shoes, the deflection is maximal in the middle of the string. So it is sufficient to view only the middle section. This explains why the string should be long, and the viewing hole is positioned at the middle of the string.

To optimize the position and tension of the string, a special adjustment tool is added. The string should be very thin, and the expected deflection is small (about 1 mm at maximum), so a couple of small lenses are included in the openings of the hole, very close to the string (Figure 3b). Figure 3a shows the basic structure of the design, in which all the above discussed aspects are applied.

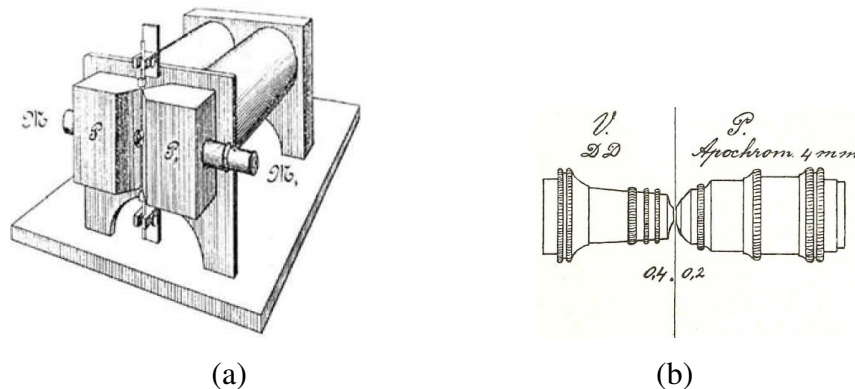

Figure 3: Basic structure of the string galvanometer [10] (a); detail of the lens position; figures are in mm [5] (b).

Obviously, during the construction of the galvanometer, many technical problems were encountered. A particular difficulty was the creation of the string itself. The first strings were made of aluminum strips, $0.75 \mu\text{m}$ thick and 0.4 mm in width [6]. Soon after these attempts, thinner wires of quartz were used. The strings were made by shooting an amount of hot liquid quartz with a crossbow over a distance away [7]. In this way, a lot of wires were made with various dimensions. For instance, wire no. 18 had a diameter of $2.3 \mu\text{m}$ and no. 25 only $1.5 \mu\text{m}$, and both had a length of about 13 cm .

However, quartz is not electrically conductive. To make the strings conductive, they were covered with a layer of silver using cathode vaporization. The wires with the numbers 18 and 25 had resistances of 6800Ω and 5200Ω , respectively. Later, much thinner wires could be realized, which resulted in a detectivity of currents down to 0.1 nA [7]. The tension of the string influences the sensitivity and response time of the galvanometer. A low tension results in a large but slow deflection, a high tension just the other way around.

For the purpose of experiments, measurements and controllability, a number of accessories was added to the basic design, for instance wind screens (to avoid interference from draught), thermal isolation of the string, and water pipes for cooling, as mentioned before. Further, a string adjustment tool was added at the upper end of the string. It is a complicated tool, allowing independent adjustment of position, alignment and tension. All this resulted in a rather complicated design (Figure 4).

A copy of the completed galvanometer is shown in Figure 5. It can be admired in Rijksmuseum Boerhaave in Leiden. Note the supports of the adjustment tool at the top to stabilize the structure.

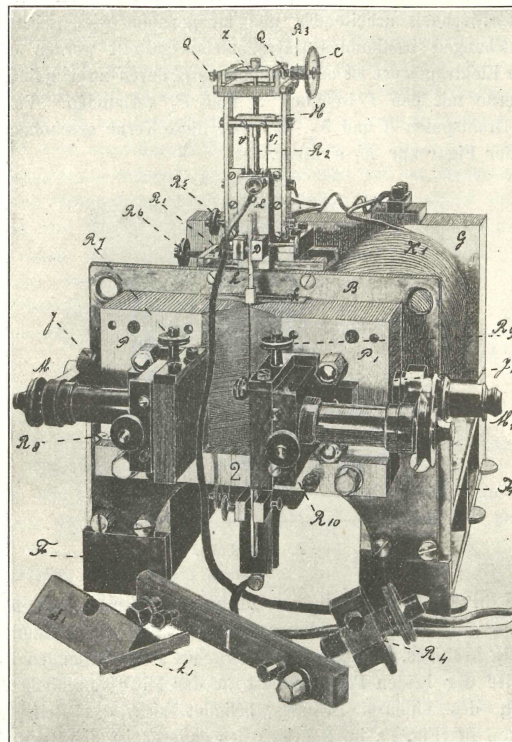

Figure 4: Design of the complete string galvanometer [5].

4 Registration of an electrocardiogram

To obtain a registration of the ECG, the movement of the string must be transferred into a written pattern. In the final construction, a light source is placed at one side of the string galvanometer, and a screen at the other side. The vibrating wire casts its shadow on this screen while first being magnified by the lens system.

The string movement is in horizontal direction, so the projection describes a horizontally moving line section on the screen. The time axis for the ECG is obtained by moving the photographic plate in vertical direction. In this way, the electrocardiogram appears vertically

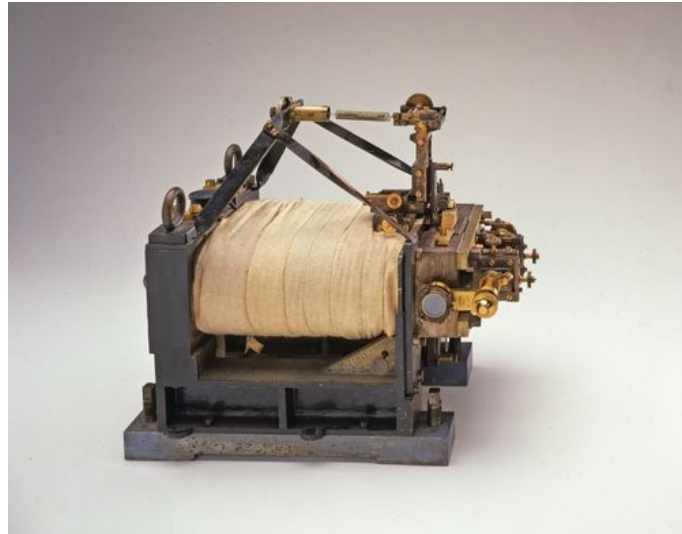

Figure 5: Copy of the final galvanometer (collection Rijksmuseum Boerhaave, Leiden, the Netherlands).

on the plate. Finally, in order to calibrate the time axis, a chopper wheel is placed between the light source and the microscope. Each time the light beam is interrupted by the non-transparent sections of the chopper wheel, a horizontal line is written on the photographic plate. By synchronizing the rotational speed of the wheel and the speed of the vertical movement of the plate, a time reference is created on the ECG. Figure 6 shows the complete electrocardiograph.

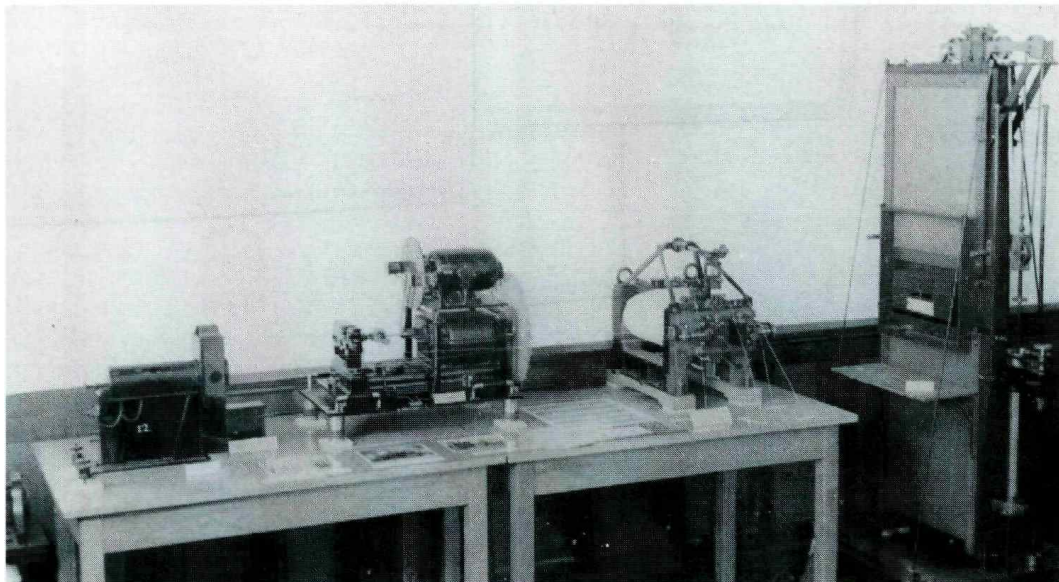

Figure 6: From left to right: the light source (carbon arc lamp), the chopper wheel, the string galvanometer and the photographic plate (falling plate camera), as designed by Einthoven [8].

The galvanometer was too heavy to be transported to patients in a hospital. To overcome this problem, Einthoven succeeded in transmitting electrocardiograms from the hospital to his laboratory 1.5 km away via (hanging) telephone cables. On March 22nd 1905 the first 'telemetry' was recorded [1].

The question arises which points on the body should be connected to the galvanometer. Intuitively these points should have a maximum distance apart for the largest effect, so one hand and one foot.

The physiologist Einthoven proposed a three-point measurement: left hand, right hand, and (left) foot. A combination of the three consecutive measurements yielded optimal information about the heart condition useful for diagnostics. Nowadays this so-called triangle of Einthoven still forms the basis for modern electrocardiograms.

5 Commercialization

Soon after his first publication, Einthoven contacted the British Cambridge Scientific Instrument Company to farm out his invention. After several years of research and engineering this company built its first galvanometer in 1905, based on Einthoven's string galvanometer. The instrument in Figure 7, built in 1911, still shows the various parts of the system conceived by Einthoven. The rebuilt string galvanometer has smaller dimensions and weight (about 25 kg). Clearly, the manufacturer has also improved the way of operation, demonstrated by the newly designed front panel. To minimize the electrical resistance of the total current path from heart to string, both hand and foot are dipped in a salt solution, to reduce the effect of the skin resistance as much as possible.

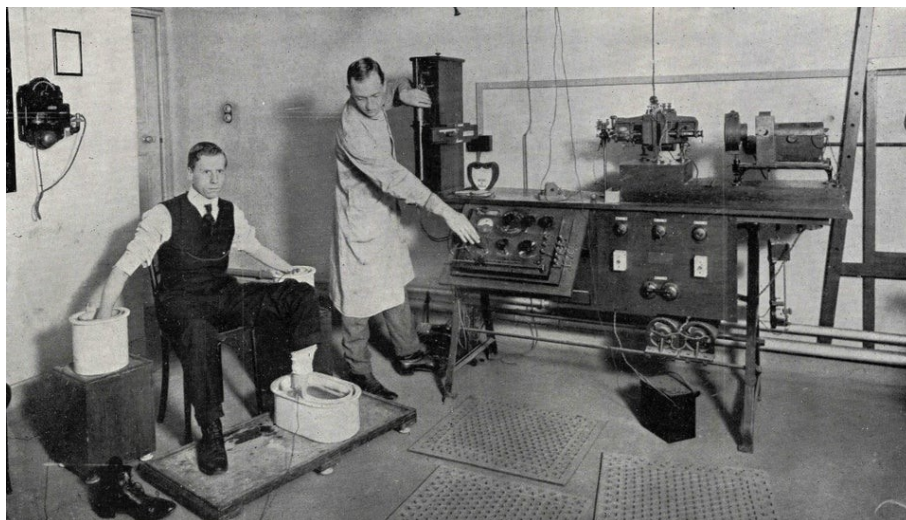

Figure 7: Three-point measurement, in the National Heart Hospital, London, 1916, using the string galvanometer built by the Cambridge Scientific Instrument Company, 1911.

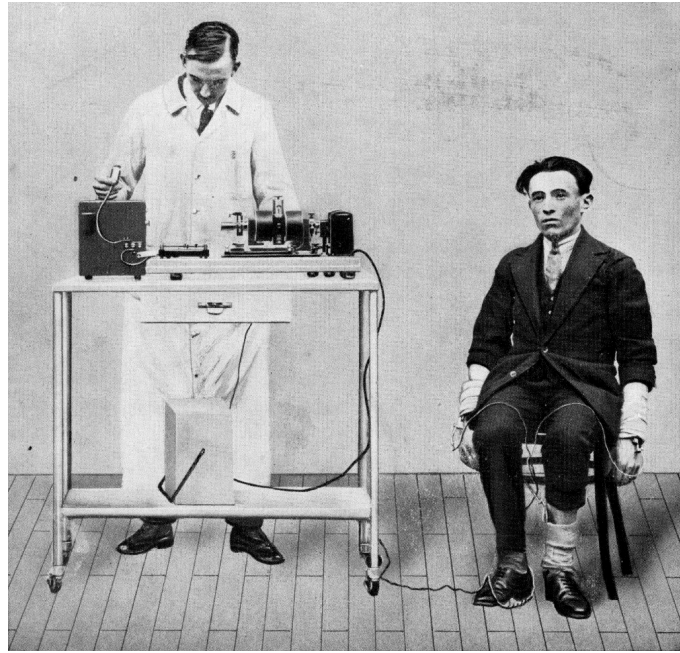

Figure 8: ECG by the French company Boulitte, around 1930.

Instrumentation engineers of the French Boulitte company succeeded in further integration of the various elements. Figure 8 shows one of the many models made by this company. The dimensions of the string galvanometer were further strongly reduced and the whole instrument made portable. Also the tubs with saline have disappeared, and replaced by bandages soaked with a saturated salt solution.

The Boulitte company has sold 115 systems in the Netherlands. All major Dutch hospitals used this instrument, until about 1950, when they were replaced by modern electronic ECG systems [9].

6 Development of electronic cardiographs

In the time period during which Einthoven developed his string galvanometer, other inventors worked on methods to amplify electrical signals, mainly for telegraphic purposes. A big step in this field was the invention in 1905 by J.A. Fleming: the vacuum diode, used as a rectifier. Soon after, in 1906, Lee de Forest introduced the vacuum triode, the first electronic device able to amplify electrical signals. Subsequent development in this area followed a course in parallel to that for the string galvanometer, however, first without much interaction. The focus on developments in electronics was mainly on signal transmission applications. Important drives were to achieve a high gain, and to minimize signal distortion. But, after some years, one recognized the potential of this technology for electrocardiology. In 1928, Ernstine and Levine reported the use of vacuum tubes to amplify the electrocardiogram instead of the mechanical amplification of the string galvanometer, and compared their ECGs to those

obtained by the string galvanometer [1].

The invention of the transistor (1948) created numerous possibilities for improving electronic equipment with respect to accuracy, size, and prize. This also heralded a new period in electrocardiography. Electronic voltage amplifiers with high input impedance became available, and soon the string galvanometer was replaced by systems based on voltage measurements. The advent of cheap computers further facilitated the registration and interpretation of ECGs. This resulted in the development of “real” portable ECG systems, including signal processing, a high resolution flat screen, and a printer. Recently, ECG-instruments for home diagnosis appeared on the market, in a great variety of models and easy to operate, for instance systems that can be directly connected to a laptop. And for the hobbyists: packages with electronic components for making your own electrocardiograph.

7 Summary and Conclusions

Neither the capillary electrometer that Einthoven used in his early attempt to register the heart’s activity nor the already available moving coil galvanometer were good enough to produce an ECG suitable for diagnosis. Hence Einthoven was forced to follow another, more difficult path to develop an alternative sensing method. This finally resulted in the invention of the string galvanometer, and the first suitable electrocardiographs. It was Einthoven who coined the Dutch word “hartfilmpje”, a word that is still used in Dutch hospitals for ECG.

Einthoven’s string galvanometer was a large, heavy instrument, hardly possible to carry it from his laboratory to patients in a hospital. He connected his instrument via telephone lines to patients over a distance of 1.5 km [1]. Despite these disadvantages, string galvanometers, in various redesigned versions, remained in use for more than half a century, until they were gradually replaced by electronic measurement systems, even during the period in which such systems came on the market.

In various review articles about the history of ECG’s, authors are doubtful about who created the first ECG, or who built the first string galvanometer. Indeed, the first ECG was already registered before Einthoven’s first publication in 1901 [11]. But the first ECG useful for diagnostic purposes was made by Einthoven with his string galvanometer.

Einthoven mentioned in a footnote in his first paper (1901) [11] the galvanometer by Clement Ader, as the inventor of the string galvanometer, in 1897. This instrument was intended to amplify Morse code signals transmitted along undersea telegraph lines. Although based on a single wire galvanometer concept, it was not a current-measuring instrument [3, 10]. Other references to earlier versions of a string galvanometer refer to more or less accidental observations of Lorentz forces acting on a wire carrying current in a magnetic environment. No evidence is found of an earlier galvanometer suitable for the measurement of very small currents, and not in the least heart activity. Certainly, Einthoven deserves the credits for having developed a string galvanometer able to record detailed electrocardiograms.

References

- [1] *A (not so) brief history of electrocardiography*, <https://ecglibrary.com/ecghist.html>
- [2] *A concise history of the ECG*, <https://en.ecgpedia.org/index.php>
- [3] J. Burnett,
“The origins of the electrocardiograph as a clinical instrument”,
Medical History, vol.29, suppl. 5, pp. 53-76, 1985,
with reference to: Clement Ader, “Sur un nouvel appareil enregistreur pour cables sous-marins”, *Comptes Rendus Hebdomadaires des Séances de l’Académie des Sciences*, vol. 124, pp. 1440-1442, 1897.
- [4] G. E. Burch, N. P. DePasquale,
“A History of Electrocardiography”,
Year Book Medical Publishers, Chicago, p. 107, 1964.
(This work is the result of a lecture given by the authors for the centennial celebration of the birth of Einthoven, Leiden, June 25, 1960.)
- [5] W. Einthoven,
“Die Konstruktion des Saitengalvanometers”,
Archiv für die gesammte Physiologie, vol. 130, no. 5-6, pp. 287-321, 1909.
- [6] C.L. de Jongh,
“Het levenswerk van Einthoven”,
Nederlands Tijdschrift voor Geneeskunde, vol. 98, no. 5, pp. 270-273, 1954.
- [7] P.J.H. Wyers,
“De snaar van de snaargalvanometer van Einthoven”,
Gewina: Tijdschrift voor de Geschiedenis der Geneeskunde, Natuurwetenschappen, Wiskunde en Techniek, vol. 19, no.2, pp. 80-94, 1996.
- [8] B. Grob,
Photograph from “De doos van Pandora - De snaargalvanometer van Willem Einthoven”,
Gewina: Tijdschrift voor de Geschiedenis der Geneeskunde, Natuurwetenschappen, Wiskunde en Techniek, vol. 25, no. 4, pp. 289-292, 2002.
- [9] P.J.H. Wyers,
“De toepassing in Nederland van de snaargalvanometer van Einthoven als elektrocardiograaf”,
Nederlands Tijdschrift voor Geneeskunde, vol.145, pp. 2465-2469, 2001.

- [10] W. Bruce Fye,
"A history of the origin, evolution, and impact of electrocardiography",
The American Journal of Cardiology, vol. 73, no.13, pp. 937-949, 1994,
doi: [https://doi.org/10.1016/0002-9149\(94\)90135-X](https://doi.org/10.1016/0002-9149(94)90135-X)
- [11] W. Einthoven,
"Un nouveau galvanomètre",
Archives Neerlandaises des Sciences Exactes et Naturelles, ser. 2, vol. 6, pp. 625-633,
1901.

Bad Vibrations – The Quarrel between Willem Einthoven and Heike Kamerlingh Onnes

Dirk van Delft

Emeritus Professor Material Culture in the Natural Sciences, Leiden University, the Netherlands*

Abstract

A significant disadvantage in operating the string galvanometer was its extreme sensitivity to earth vibrations. Einthoven's bad luck was the vicinity of the cryogenic laboratory of Kamerlingh Onnes. At a distance of less than a hundred meters, a steam engine and a gas engine produced an abundance of such vibrations. Even stone pillars in the floor, unconnected to the foundations of the physiology laboratory, couldn't prevent these vibrations from disturbing the recordings of electrocardiograms. From 1895 onwards, Einthoven repeatedly wrote to his neighbor that he was in urgent need of a solution. Ten years later, a major quarrel evolved between the two directors. After a flurry of lengthy and increasingly bad-tempered letters back and forth, the subsequent correspondence between Einthoven and Kamerlingh Onnes degenerated into a full-scale slanging match. J.D. van der Waals, who had joined the Board of Curators of Leiden University after his retirement as an Amsterdam physics professor in 1908, stepped into the arena as referee. As a result, Kamerlingh Onnes came up with a detailed timetable for operating his engines, to which Einthoven reluctantly added his signature. The string galvanometer continued to deliver ECGs, but the quarrel between Einthoven and Kamerlingh Onnes was never settled.

It all started with a bang. The laboratories of Willem Einthoven (physiology) and his colleague Heike Kamerlingh Onnes (physics) were built on a spot called 'Small Ruin', see Figure 1. On January 12, 1807, Leiden suffered a devastating explosion of a gunpowder ship that completely illegally had moored in the Rapenburg canal. Half a century later, this scar from Napoleonic times made way for brand-new laboratories and cabinets for the Leiden University departments of Chemistry, Physics, Anatomy, and physiology.

In the history of science, this Small Ruin is a very special place. The laboratories and cabinets built at this part of Leiden facilitated a bunch of Nobel Prize-winning researchers. First, experimentalist Pieter Zeeman, who discovered in 1896 the magnetic Zeeman effect,

*Email: delftd@lorentz.leidenuniv.nl



Figure 1: Laboratories at the 'Small Ruin' / Steenschuur, ca. 1925. Foreground: Physics Laboratory. Backside: Physiology Laboratory.

explained by the theoretical physicist professor Hendrik Lorentz. The two of them were awarded the 1902 Nobel Prize in Physics. Johannes Diderik van der Waals, who did PhD research with the Leiden physics professor Rijke as his supervisor, won the Nobel Prize in 1910 for his molecular research, resulting in his 'equation of states.' Three years later, Heike Kamerlingh Onnes won a Nobel Prize for the liquefaction of helium in 1908, reaching temperatures as low as a few degrees above absolute zero (-273 degrees Celsius). And last but not least, Willem Einthoven was awarded a Nobel Prize in 1924 for his 'discovery of the mechanism of the electrocardiogram'.

So that's five Nobel Prize winners in 22 years, resulting in a number of Nobel Prize winners per year per square meter that nowhere on earth has ever been surpassed. A very special place indeed!

Willem Einthoven timeline

- 1860 Born in Semarang (Java, Dutch Indies)
- 1878 Exam HBS (high school), start study of medicine at Utrecht University
- 1885 Ph.D. (supervisor F.C. Donders, ophthalmology), Utrecht University
- 1886 Professor in physiology, Leiden University (25 years old)
- 1892 Bronchial asthma research
- 1895 Physiological optics
- 1901 String galvanometer
- 1902 First human electrocardiogram with the string galvanometer
- 1905 First telecardiogram
- 1924 Nobel Prize in Physiology or Medicine
- 1927 Death

Before embarking on the quarrel between Einthoven and his neighbor Kamerlingh Onnes, let me provide some personal information on the physiologist. See the timeline. Willem Einthoven was born in Semarang on the isle of Java in the Dutch Indies, where his father was a medical doctor in the Dutch colonial army. At the age of 10, his father died and Willem and his family moved to the Netherlands. In Utrecht, Willem visited a new type of high school (HBS, hogere burgerschool) founded in 1863 that proved to be of immense importance for Dutch science because of its emphasis on the study of mathematics, physics, and chemistry. Almost all Dutch Nobel Prize winners enjoyed this type of education, and not the – in those days – old-fashioned gymnasium, a type of high-school emphasizing classical (Greek, Latin) languages and culture. At Utrecht University, Willem studied medicine. His favorite teachers were physicist Buys Ballot and ophthalmologist Donders. The latter was his Ph.D. supervisor. Einthoven's topic: stereoscopy by color difference.

1 Absurd-looking agreement

The Physics Laboratory kept a special file for instructions and recipes, from procedures for cleaning batteries, making carbon copies on the Hammond typewriter, blackening brass and silvering mirrors to a recipe for 'Ramsay stopcock grease'. Another folder contained all the special regulations that applied in the laboratory. Since a safety controversy about a collection of 'explosive devices' that had paralyzed the laboratory from 1895 until 1898, carefully records had been kept of all canisters of compressed or liquid gases on the premises. A register in the corridor had a separate card for each canister, with the date of receipt, name of the gas, make and serial number of the gas canister, storage place within the laboratory, pressure, weight, and empty weight. Whenever a canister was moved, the details were updated, including the reason for the move. It was forbidden to place gas canisters near heaters or to expose them to direct sunlight for any length of time. Where safety was concerned, Kamerlingh Onnes was stricter than any authority had ever required. One of the documents in this 'special regulations' folder was an absurd-looking agreement with the physiologist Willem Einthoven, whose building was adjacent to the Physics Laboratory. It specified in detail the times at which Kamerlingh Onnes could use his pumps and machines (see Figure 2), and began like this: "The steam engine shall not be operated: on Monday, Tuesday, Wednesday or Thursday evening after 7 p.m., or on Wednesday afternoon after 2 p.m. Operation shall also be forbidden at other exceptional times, in response to a request submitted by Professor Einthoven at least hours in advance. When it is necessary to operate the gas engine on evenings on which the steam engine is idle, this shall be communicated three days in advance. Should it later transpire that it will not in fact be necessary to operate the gas engine that evening, this will be communicated without delay. The number of steam-engine-free evenings on which the gas engine is operated shall not exceed 24 during any 3-month period."

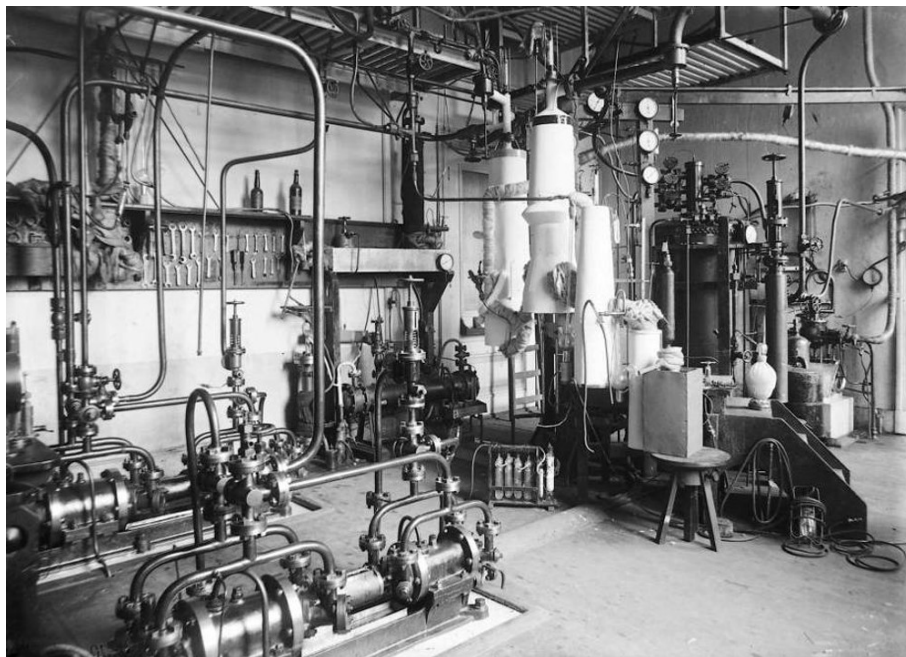

Figure 2: Equipment for liquefying air, ca. 1895 / credit: Leiden Institute of Physics

And so on and so forth. Given the strong terms and immense detail in which this agreement was couched, the reader will not be surprised to learn that Kamerlingh Onnes and Einthoven were not friends, and that the agreement was the result of a fairly unpleasant series of negotiations.

How had this unpleasantness arisen? The site, known since the gunpowder disaster as the 'Small Ruin,' was occupied by a huddle of four laboratories: anatomy, chemistry, physics, and physiology. The first three shared the Steenshuur building, with physics occupying the right wing, chemistry the left, and anatomy the rear section. Kamerlingh Onnes dearly wanted to have the entire building to himself – in 1894 he submitted detailed plans for the chemistry wing – and the repeated delays in building the new chemistry laboratory (organic chemistry had moved to the Vreewijk quarter in 1901) was a thorn in his side. Plagued by a lack of space, Kamerlingh Onnes (see Figure 3) was constantly complaining to the Board of Curators of Leiden University about his 'increasingly dire situation'. But he was on extremely good terms with his chemistry neighbors (first Van Bemmelen, and later Schreinemakers), and the two departments frequently helped each other out. One chemistry assistant (Meerburg) helped to heat the ethylene, and another (Filippo) helped with the extraction of gases (for instance, helium from monazite sand). Since the departure of Zaaier, anatomy professor and one of the complainants in the 1895 safety affair, Kamerlingh Onnes had also been on amicable terms with the anatomy department.

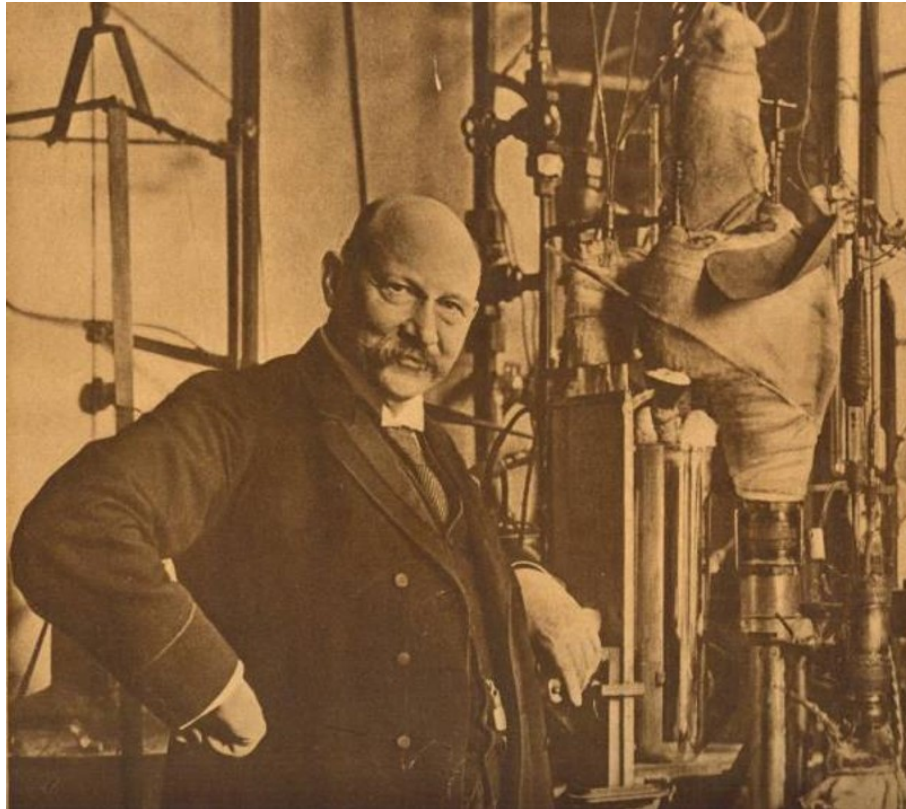

Figure 3: Heike Kamerlingh Onnes in his cryogenic laboratory, 1913 / credit: Leiden Institute of Physics

2 Major disadvantage

Physiology was a different matter. The dynamic Willem Einthoven had been appointed professor and director of the Zonneveldsteeg Physiology Laboratory in 1886, at only 25 years of age, and he was soon presiding over ground-breaking research on respiration, bronchial asthma, the eye, and the electrophysiology of the heart. Einthoven tackled things on a smaller scale than Kamerlingh Onnes, but otherwise there were many similarities: they shared the same inventiveness, perseverance, and gift for diplomacy. And Einthoven, like Kamerlingh Onnes, hated wasting time and preferred upgrading his existing lab to moving elsewhere.

Relations soured in the 1890s when Einthoven started working on the electrical registration of cardiac activity. Initially he used a capillary electrometer, but this slow, mercury-filled instrument soon proved unsatisfactory, and he went looking for something better. Finally, he designed his own solution, in the form of a ‘string galvanometer’, which he presented in 1901. A very thin silver-coated quartz wire placed in the homogeneous field of a magnet coil started oscillating in a lateral direction as a result of the Lorentz force that the small cardiac currents exerted on the wire.

While he was developing this instrument, Einthoven borrowed various items from his neighbor Kamerlingh Onnes, such as a Rühmkorff inductor (1895-96) and a Thomson gal-

vanometer (1899-1901). So far, so good.

In 1905 Einthoven even succeeded in measuring so-called telecardiograms of patients with heart disease at the local Academic Hospital, with electrodes connected to his wire galvanometer by a 1.5-kilometer-long cable. For his 'discovery of the mechanism of the electrocardiogram' Einthoven was awarded the Nobel Prize for Medicine or Physiology in 1924.

A major disadvantage of the string galvanometer was its extreme sensitivity to earth vibrations in the vicinity. And Kamerlingh Onnes's steam engine and gas engine produced an abundance of such vibrations. To solve the problem, Einthoven – like Kamerlingh Onnes himself – had built a vibration-free room at his physiology laboratory by installing a 100-ton stone pillar in the floor, unconnected to the foundations. It helped, but it was not always sufficient, and from 1895 onwards, Einthoven repeatedly wrote that he was in urgent need of a solution.

Einthoven had never opposed Kamerlingh Onnes during the latter's long safety controversy with the authorities from 1895 until 1898, but the director of the Physics Laboratory had never been willing to guarantee a lack of vibration in return, complained an embittered Einthoven in 1905, 'not even for one hour!' Three years earlier, the two had still been on comradely terms. Kamerlingh Onnes had finally obtained permission to build a new boiler-house on Langebrug; he planned to put a steam boiler there to provide the laboratory with central heating. The steam engine, the mobile 15-hp Westinghouse he had bought in 1887, would be installed in the new control room adjoining the boiler-house. A new license under the Dutch Nuisance Act 1875 would be needed for all this, and Kamerlingh Onnes sent off the application to the Community of Leiden in April 1902.

As in the safety dispute of 1895, neighbors were given an opportunity to object, but no one did so. At the June meeting of the Academy of Sciences, Einthoven too assured Kamerlingh Onnes that he would not make any trouble. 'I said that it would be impossible to undertake an obligation not to use the steam engine for a certain number of days', noted Kamerlingh Onnes after that exchange in Amsterdam's Trippenhuis (seat of the Royal Dutch Academy of Science). 'Only in an emergency we might be able to rely on a large storage battery.' For if the pumps in the cryogenic laboratory were powered by batteries, the steam engine and gas engine could be turned off, allowing Einthoven to use his string galvanometer without any disruptive vibrations.

3 Bureaucratic hullabaloo

But in 1905, when Kamerlingh Onnes decided he needed a more powerful, 25-hp steam engine (and wanted to increase the pressure in the boiler from 6 to 8 atmospheres), Einthoven – who was in the process of developing his telecardiograms – could not take it any longer. This time he did submit a notice of objection, setting in motion another bureaucratic hulla-

baloo like the one in the 1890s, which was pursued right up to the Council of State.

Although Kamerlingh Onnes assured the committee set up by the Provincial Executive that he would install the new, 'quieter' steam engine with special care, reducing rather than increasing the level of vibration, Einthoven insisted that more steam power meant more misery for his laboratory. Kamerlingh Onnes also offered to use batteries – Leiden did not acquire mains power until 1907 – instead of the new steam engine four evenings a week, and even on special occasions in the daytime, if requested three hours in advance, but to no avail.

At this point in time, the Minister of Education instructed the combatants to draw up their own contract. This was no easy task since Einthoven – to Kamerlingh Onnes's great annoyance – insisted on bringing in not just the steam engine but also the steam compressors and electric motors for which Kamerlingh Onnes had secured a license many years before. Switching off the machines that produced power in the evening was often impossible, said Kamerlingh Onnes. This was because the room where magnetic measurements were recorded was right underneath the lecture hall where Hendrik Lorentz, professor in theoretical physics since 1877, taught his medical students. And students moving about disturbed the galvanometers, which meant that measurements had to be taken in the evening.

After a flurry of lengthy and increasingly bad-tempered letters back and forth, Kamerlingh Onnes came up with the agreement containing the passage quoted above, to which Einthoven reluctantly added his signature. Ensuring compliance was a fresh administrative challenge: '12 times in each three-month period, before 10 a.m., notification will be given that on evenings on which the steam engine and gas engine will be idle, the electric motors and small steam compressors with a combined capacity exceeding 1 hp will also not be operated.'

4 A weather eye

Things went wrong again in April 1908, when Kamerlingh Onnes acquired a 4-hp Brotherhood steam compression pump on loan from the navy. It came with ten cylinders for compressed gas, which were useful for storing hydrogen – an essential ingredient in preparing liquid helium. Yet another licence was needed, and Einthoven – who kept a weather eye on any increase in vibrations – protested again. 'What an awful business', groaned Kamerlingh Onnes to his right-hand man, August Crommelin. 'I would never have thought it remotely possible: objecting to a little 3-hp pump that is, I believe, 50 meters away (from Einthoven's vibration-free lab), while the 25-hp steam engine and 40-hp gas engine are both so much closer.'

In Kamerlingh Onnes's eyes, the license application had been a 'mere formality', and he considered Einthoven's whining about 'serious harm' and 'increased vibration' to be entirely misplaced. Einthoven, in his turn, considered that no one but he could judge the ad-

verse effects. The subsequent correspondence degenerated into a full-scale slanging match. Einthoven felt that Kamerlingh Onnes refused to take his objections seriously, while Kamerlingh Onnes thought that Einthoven was making a mountain out of a molehill and made no bones about it in his letter of December 12, 1908. After politely thanking Einthoven for congratulating him on the liquid helium triumph (on July 10, Kamerlingh Onnes, after a fierce battle with James Dewar, had won the race, making Leiden ‘the coldest spot on earth’) he abandoned his cordial tone altogether: ‘How gladly would I forget the delay that you caused in the work that led to the liquefaction of helium, by your actions against the Physics Laboratory. And look now! You are already doing the exact opposite of promoting the further achievements that you wish the cryogenic laboratory once again, without gaining any real benefit for your own work.’

Kamerlingh Onnes was particularly annoyed that he had closed down his steam and gas engines on Wednesday afternoons, ‘greatly to the detriment of the work’, to give Einthoven an opportunity to do some delicate experiments, only to hear the gas engine of the Physiology Laboratory roaring away on those same Wednesday afternoons.

Kamerlingh Onnes considered Einthoven’s request that the new pump not be used after 11 o’clock in the morning without the approval of the Physiology Laboratory or his deputy simply impracticable. ‘Leaving aside the fact,’ he added, ‘that it is hardly proper that I should have to ask the subordinate of a younger colleague for permission to do something I deem to be desirable.’

Einthoven was so furious that he declared the correspondence to be at an end, which Kamerlingh Onnes acknowledged ‘with surprise but also regret’. To move the matter along, he wrote to the Board of Curators that he would use the new pump solely to replace the two (by then malfunctioning) Brotherhood pumps he already had, such as to cause no increase in vibrations at all. Replacing these pumps with new ones, as Einthoven had suggested, would cost several thousand guilders, he added, whereas the new pump he had just acquired was free.

Once Kamerlingh Onnes had been granted his license, he would do an experiment to convince Einthoven; only then would the pump be made operational. This was an offer that the Board of Curators and the Minister of Education could hardly refuse – the financial argument must have been compelling in any case – and the license was quickly granted.

Then came the squabbling about the experiment. Kamerlingh Onnes’s mentor Johannes Diderik van der Waals, who had joined the Board of Curators of Leiden University after his retirement in 1908 in Amsterdam, stepped into the arena as referee. By July 1909, the ordeal was finally over, and a relieved Kamerlingh Onnes thanked his friend for all the trouble he had taken. ‘What would have happened had you not intervened?’ he wrote to Amsterdam, adding: ‘One can hardly imagine a greater hindrance to one’s work than exposure to an attack such as this one by Einthoven.’

5 Deaf to the protests

The quarrel with Einthoven was never patched up. When Einthoven too presented plans for expansion in 1913 and started eying the chemistry department's garden, Kamerlingh Onnes lost no time in pointing out his prior claim. When Kamerlingh Onnes finally took possession of the chemistry wing immediately after the First World War, he embarked on a major program of expansion and renovation, and Einthoven found himself hemmed in.

Kamerlingh Onnes was deaf to the protests of his sole remaining neighbor against the new upper storey planned for the theoretical physics building, even after Lorentz and Paul Ehrenfest (who succeeded Lorentz in 1912) had suggested forgoing the expansion to keep the peace. Kamerlingh Onnes wanted theoretical physics close by, and that was that. Even at the end of his career there was to be no reconciliation. When Kamerlingh Onnes received a visiting Japanese professor in 1924 who also wanted to see Einthoven's string galvanometer, he asked his longtime colleague and successor Willem Keesom to arrange it.

Kamerlingh Onnes died in 1926, Einthoven one year later. Both had preferred to stay and adapt their laboratories instead of moving to a new laboratory, losing time in the process. Only at the end of the 1950s, the Physiology Laboratory moved to the Boerhaave district, located behind the Leiden central train station. Since 2008 the building bears Einthoven's name. And on April 8, 2022, precisely eleven years after presenting one to honor Kamerlingh Onnes's discovery of superconductivity in 1911, the IEEE came up with a Milestone Award for Einthoven's innovative and ground-breaking string galvanometer. All's well that ends well.

Further reading

D. van Delft,

Freezing physics. Heike Kamerlingh Onnes and the quest for cold,

Edita KNAW, Amsterdam, 2007.

A Selection of the Photographic Glass Recordings by Einthoven and Coworkers

Norbert M. van Hemel*, Pascal F.H.M. van Dessel†
and Jacques M.T. de Bakker‡

* Emeritus Professor Clinical Heart Stimulation, Utrecht University, the Netherlands

† Cardiology Department, Medisch Spectrum Twente, the Netherlands

‡ Emeritus Professor Experimental Cardiology, Amsterdam University, the Netherlands
Department of Medical Physiology, Utrecht University, the Netherlands

Abstract

Einthoven's publication of the first human electrocardiogram recorded with the string galvanometer (1902), followed by the "Le Télécardiogramme" (1906), initiated new insights into the mechanism of cardiac currents and their appearance in the human and animal ECG. Einthoven also introduced the worldwide accepted recording speed and calibration of the ECG signals as well as the nomenclature of the ECG components.

As a non-practicing physician, Einthoven had to rely on clinical contributions by others for the interpretation of abnormal ECG recordings of patients. Dr. Thomas Lewis (London, UK) appeared indispensable in this regard. Optimizing the string galvanometer permitted Einthoven and his fellows to explore electrical signals generated by the eye and peripheral muscles. This resulted in the simultaneous recording of cardiac sounds, respiration, and arterial and venous pulse curves with the single-lead ECG and later the three-lead ECG. With their subtle recording equipment, Einthoven and coworkers could investigate the effects of pharmacological interventions and the time relation between the onset of cardiac electrical excitation and mechanical contraction.

The collection of the glass plates in the Rijksmuseum Boerhaave Leiden shows the photographic recordings of these scientific explorations from 1894-1931. Our current contribution addresses some highlights of these photographic recordings that reflect the large variety of Einthoven's human and laboratory studies.

1 Introduction

Since 1940 the Rijksmuseum Boerhaave in Leiden has taken care of 24 wooden boxes filled with 2394 strips of glass with a size of 4 cm high and 15 cm long. These strips constitute the photographic recordings (negatives) made by Willem Einthoven, his coworkers, trainees, and

technical assistants, mainly made with the string galvanometer, the first operational copy of which was accomplished around 1902 [1]. The time frame of these photographic recordings was 1894 to 1931. The site of production was the Physiological Laboratory of the University of Leiden.

In 2013 we were invited by the museum to inspect these glass recordings with the request to define these recordings' historical contribution to the development of the electrocardiogram (ECG). We selected 135 glass plates (5.6%) from the total collection to assemble the book about this subject [2]. The selection criteria of this "short list" were the photographic quality of the recording, the quality of the recorded signals, and the interpretability of the recording. Most of the glass plates were rejected due to repeated or identical subjects or variations of a theme, for example, the sweep of the recording or signal amplitude. Sometimes the content could not be classified at all. The correspondence and papers of Einthoven and his fellows and the books of Prof. H.A. Snellen [3] and Dr. A. de Waart [4] provided many details to understand these glass plates' historical and scientific significance.

During the selection process, we soon became aware that this glass plate collection contained more than only ECG recordings. The current paper aims to unfold the impressive diversity of scientific subjects recorded with the string galvanometer designed by Einthoven and his coworkers. Einthoven is often called the "Father of Electrocardiography" [3], but after further technical improvements, Einthoven applied the string galvanometer also for neurological, ophthalmological, pharmacological, and radiotelegraphic investigations.

2 Selected Glass plates and Related Information

2.1 Calibration of the string galvanometer

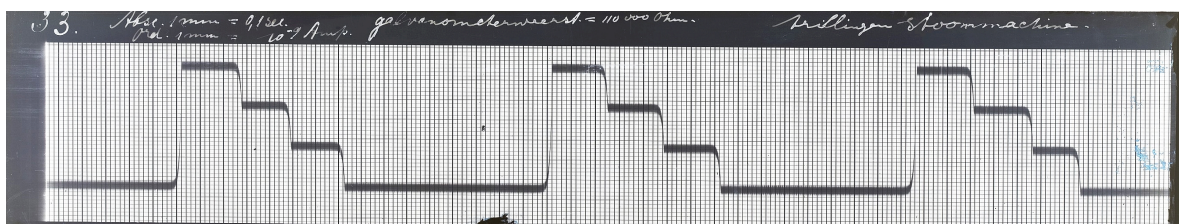

Figure 1: Calibration signal of the string galvanometer. Abscissa: 1 mm = 0.1 s; ordinate: 1 mm = 10^{-9} A; galvanometer resistance: 110.000 Ohm. "Trillingen stoommachine" = steam engine vibrations. Date of recording: not indicated; most likely 1903. Read from right to left.

Einthoven spent much energy on the string-galvanometer's mathematical and technical aspects. Figure 1 shows the calibration signal of the string. The picture represents the deflection of the string after an initial current of 10 nA (10^{-8} A). After 1.2 s, the current is

increased to 20 nA, and after 2.4 s to 30 nA. The upstrokes in the signal are fast, indicating that the string's tension is high. A lower tension increases sensitivity but decreases response time. The note "trillingen stoommachine" (steam engine vibrations) indicates that this calibration recording was made during an operating steam engine (most likely the steam engine in the nearby physics laboratory, used by Prof. Kamerlingh Onnes in his low-temperature experiments); it seems not to have disturbed the galvanometer signal. During this calibration, the resistance of the galvanometer was 110 kOhm. The resistance of the string was usually in the range of 10 kOhm. Obviously, an additional resistance was added to increase the electromagnetic damping of the string.

2.2 The first telecardiogram

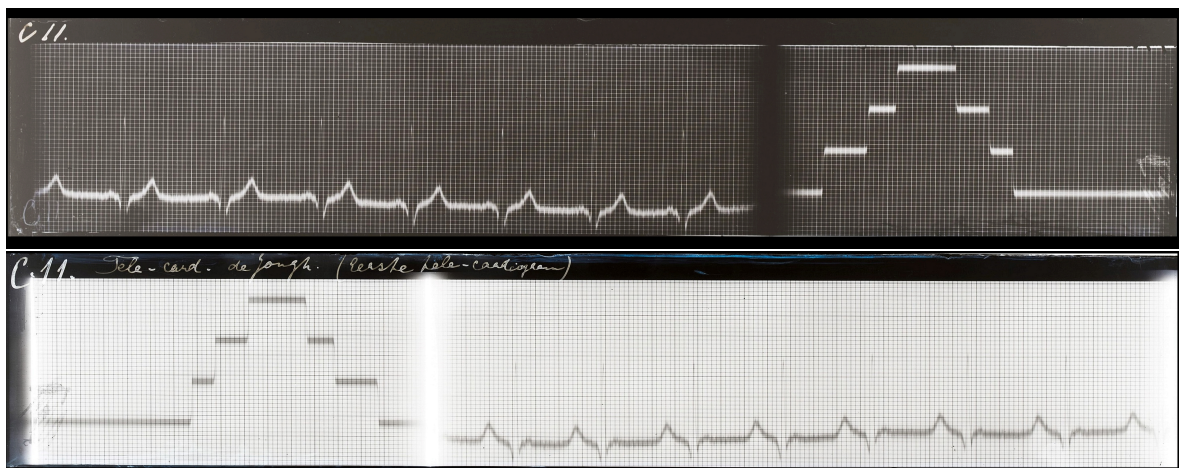

Figure 2: The first telecardiogram. This ECG of Mr. C.L. de Jongh, one of Einthoven's assistants, was made on March 22, 1905, in the Hospital of the University of Leiden. The electrocardiographic (probably) lead I shows normal P waves, QRS complexes and repolarization and also the calibration signals. Paper speed is 25mm/s. The upper panel is the negative copy, while the lower one is the positive copy. Read the upper panel from left to right and the lower panel in the reverse way.

The string galvanometer could not be moved to the University Hospital due to its heavy weight and the required vibration-free positioning of the device. Therefore, patients' ECGs were recorded online through a standard telephone cable over a mile distance between the hospital and the physiologic laboratory. Einthoven called these clinical single-lead ECGs "Telecardiogram" [5]. He was, "Avant la lettre", the first investigator who performed tele-monitoring, an application of electrocardiography that is nowadays worldwide in use.

2.3 The electrocardiogram of Willem Einthoven

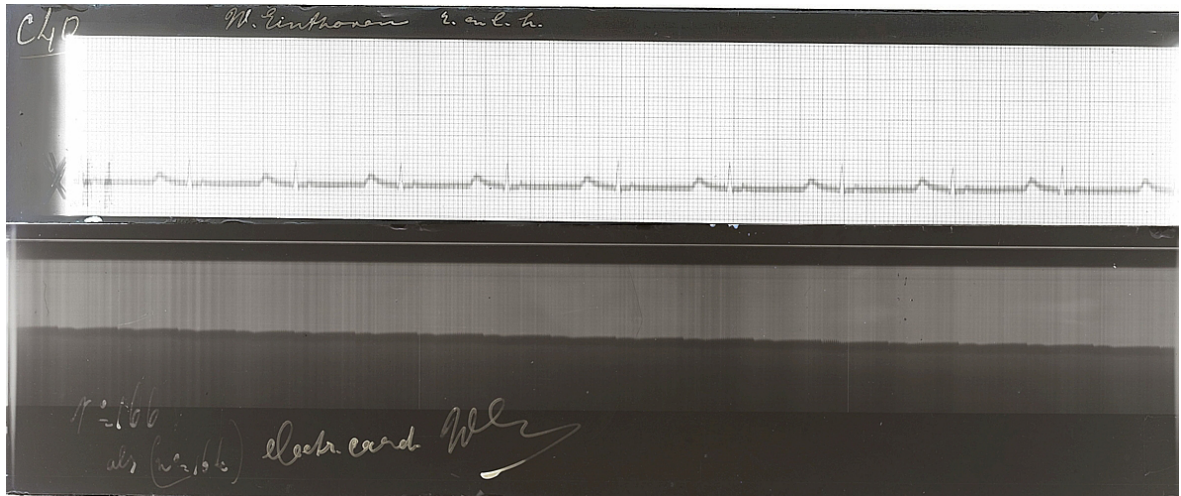

Figure 3: The electrocardiogram of Willem Einthoven. Upper panel: the lead-I ECG (read from right to left) of W. Einthoven, made in 1904/1905, at the age of 45 years. This recording was never published or shown in public. Lower panel: Einthoven's ECG as recorded by Lippmann's capillary electrometer on June 23, 1893.

A surprise was the discovery of the electrocardiographic lead I recording of W. Einthoven himself, made in 1904/5 at the age of 45 years (Figure 3, upper panel). The recording shows a sinus bradycardia of 60 beats per minute, reflecting his excellent physical condition (Einthoven was a well-trained all-round sportsman). This recording was never printed, published or shown in public. Of considerable interest is the recording of Einthoven's ECG (Figure 3, lower panel), made in June 1893 with Lippmann's capillary electrometer [6]. The P and QRS waves are hardly discernable. This recording method aroused Einthoven's mathematical work that eventually resulted in his concept of the P, Q, R, S, T, and U waves in the ECG, their calibration, and the initial clinical interpretation to discern normal and abnormal ECG signals.

2.4 Total atrioventricular block

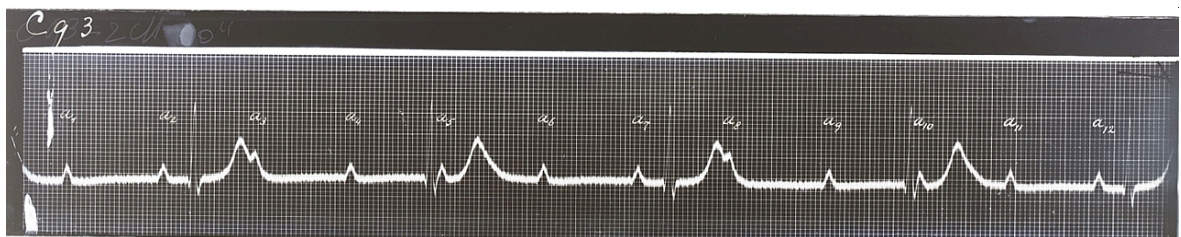

Figure 4: Total atrioventricular block, recorded in 1904. ECG lead II. a_1 - a_{12} are markers of atrial waves. Read from right to left; paper speed 25 mm/s.

For centuries a very slow heart rate was diagnosed by listening to the heart or by feeling the pulse; the cause of this abnormality remained often concealed. However, this cardiac conduction disturbance could be easily understood from the first recording of a total atrio-ventricular block as made by Einthoven in 1904 (Figure 4). The heart rate (ventricular rate) in this recording is < 20 beats per minute, while the atrial rate is 75 beats per minute. Until the advent of the implantable pacemaker, this cardiac disease was lethal.

2.5 Effect of respiration on heart rate

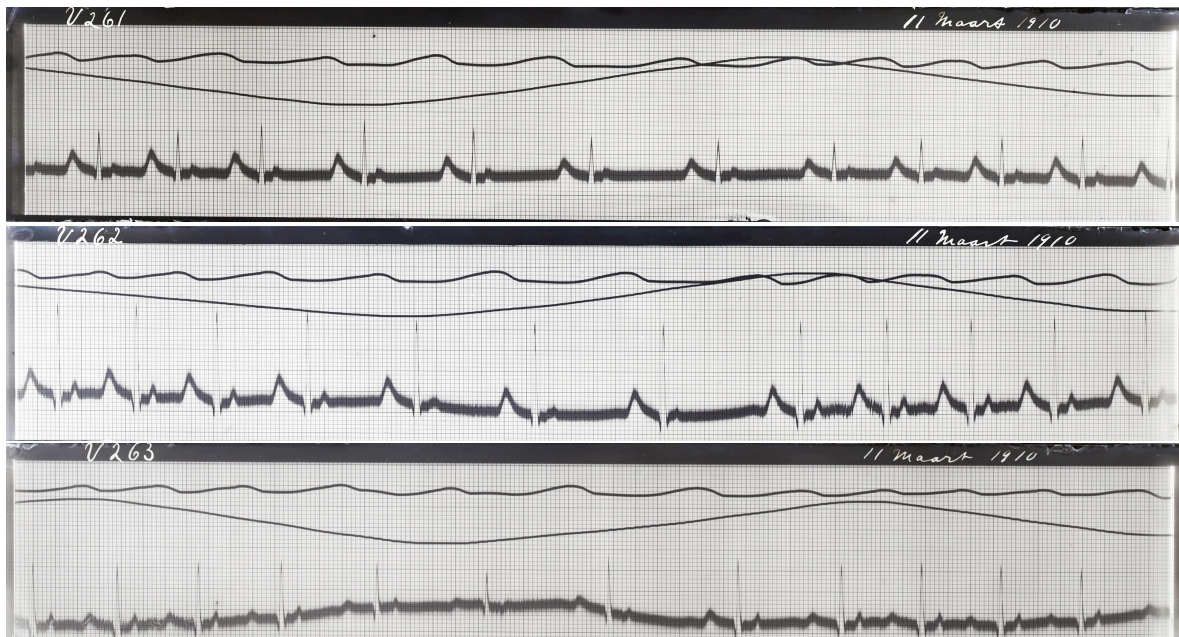

Figure 5: The effect of respiration on heart rate and ECG waveshapes (March 11, 1910). The recordings show the external pulse curve (top), the respiration curve with the ascending movement indicating inspiration and the descending movement indicating expiration (middle), and, from the top to the bottom panel, the electrocardiographic leads I, II, and III, respectively. Read the pictures from right to left. Paper speed 25mm/s. Note that the recordings were not made simultaneously.

Simultaneous recording of several biological signals delivered more insight into the relation and mutual interaction of physiological events [7]. The recordings in Figure 5 show the effects of respiration on heart rate and QRS morphology. During inspiration, heart rate drops, P waves change, and the QRS amplitude decreases because of the increasing distance between the heart and the exploring electrodes.

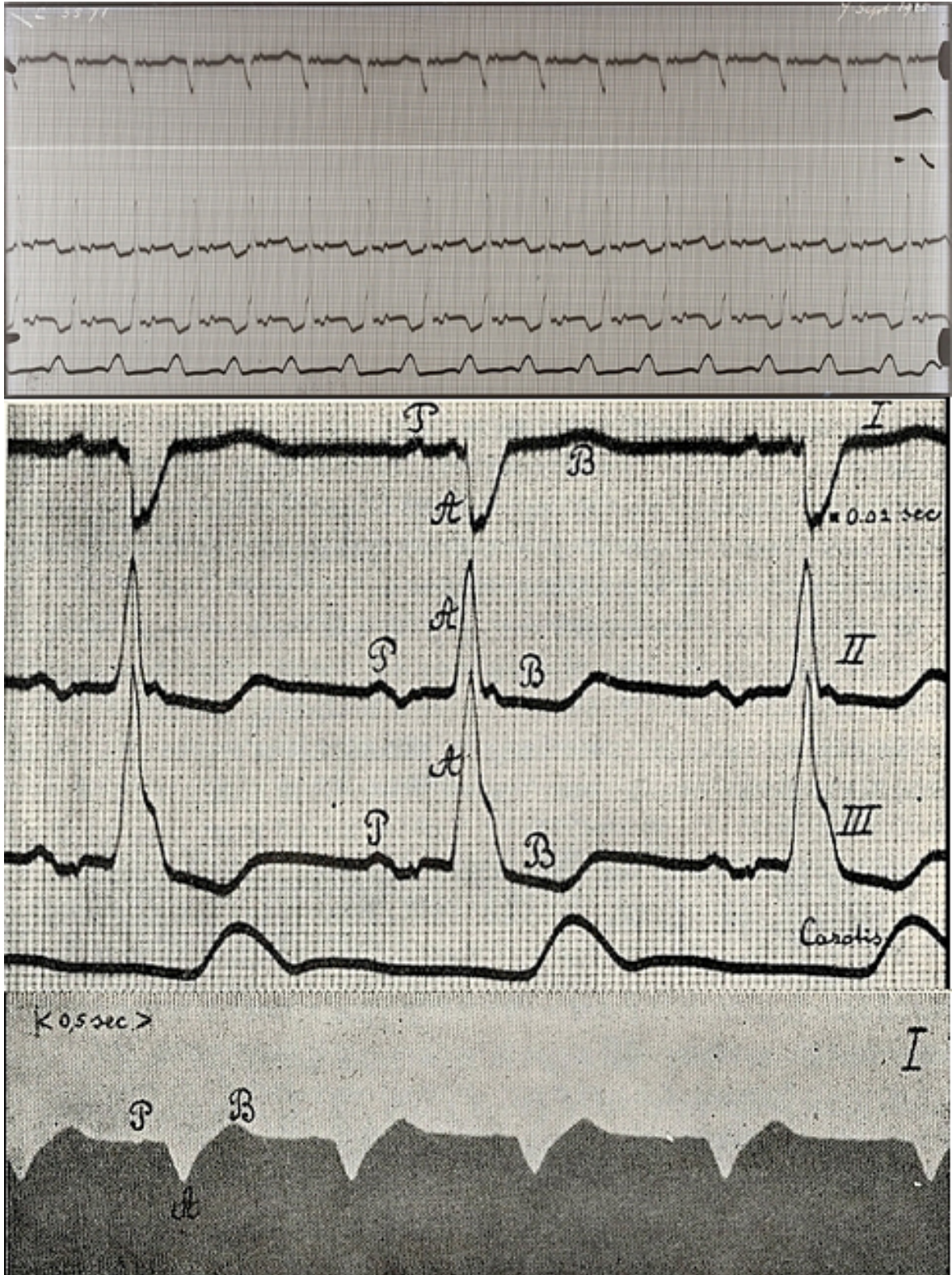

Figure 6: The 3-lead electrocardiogram. Upper panel: 3-lead galvanometer ECG plus carotid curve, recorded on September 7, 1925; read from right to left. Middle panel: enlarged part of the same recording; appeared as fig. 58B in [4], read from right to left, paper speed 0.10 mm/s. Lower panel: ECG lead I of the same patient, recorded by the capillary electrometer on June 15, 1894; appeared as fig. 58A in [4].

2.6 The 3-lead electrocardiogram

Einthoven and his team were constantly improving the technical facilities of the string galvanometer recordings. The advent of the simultaneous 3-lead ECG recording initiated a new step of electrocardiography that offered more insight into the conduction of currents through the heart.

This 3-channel ECG with the arterial carotid curve shown in the upper and middle panels of Figure 6 shows prolonged AV conduction, right ventricular hypertrophy, and left posterior hemiblock. It was made in 1925 in a patient who was 79 years of age. Strikingly, 31 years earlier, Einthoven had recorded the lead I ECG of the same patient with the capillary electrometer [4], see the lower panel of Figure 6. The ECG pattern had not changed since. This abnormality is probably caused by a congenital cardiac disease like pulmonary valve stenosis or the disease of Fallot.

2.7 Sinus rhythm, ventricular extrasystoles and fusion beats



Figure 7: Carotid artery pulse curve and lead II ECG, recorded on June 12, 1909, showing sinus rhythm, ventricular extrasystoles, and fusion beats.

Einthoven and his fellows recorded a large variety of cardiac arrhythmias. They examined the effects of the irregular heartbeat on cardiac contraction and output by recording the ECG and the peripheral arterial pulse simultaneously. The example in Figure 7 shows sinus rhythm, sinus arrhythmia, and ventricular ectopic beats with varying coupling intervals. Connected to the physician in the hospital by telephone, Einthoven, in his laboratory and seeing the ECG of the patient, could timely announce an "intermission," a skipped beat (an extrasystole without effective stroke volume), that occurred before the doctor in the hospital could detect this event by feeling the pulse. Examples of such events can be seen in the lower panel of Figure 7: as evidenced by the carotid pulse curve, the 4-th and 5-th extrasystoles in the ECG are not resulting in blood pressure pulsations. Hence, it takes some time to detect these extrasystoles by palpating the patient's pulse.

This event prompted Snellen, in his biography of Einthoven, to mention: "Unfortunately, the examination of the hospital patients soon came to an end, as the clinician was no longer interested and ceased to cooperate. One of the most irritating aspects of electrocardiography seems to have been that Einthoven was able to announce by telephone an intermission of the pulse (because of an extrasystole) just before it actually occurred" [8].

2.8 Einthoven and Lewis



Figure 8: Photograph of W. Einthoven (left) taken at the last visit of Dr. Thomas Lewis to Leiden, probably in 1921 (courtesy of Rijksmuseum Boerhaave, Leiden).

Einthoven needed fiercely to receive clinical input and advice from elsewhere beyond the Leiden clinic. In May 1908, Dr. Thomas Lewis from London, UK, wrote his first letter to W. Einthoven [8] with the request to receive a copy of the Einthoven paper entitled "Le Télécardiogramme," published in the French language in 1906. Notably, Einthoven submitted his papers to French, English, German and Dutch journals, thereby showing his skillful use of foreign languages. Lewis's letter was the starting point of 20 years of mutual interaction between the very interested clinician Lewis and the physiologist and experimentally minded Einthoven. Einthoven profited from Lewis' clinical and experimental cardiac studies, for example, "auricular tachycardia" [8, 9]. Lewis, 20 years younger, profited from Einthoven's technical and mathematical advice. The correspondence and visits to London

and Leiden yielded important mutual benefits. In 1908, Lewis ordered a commercial string galvanometer from Edelmann in Munich and asked Einthoven technical questions regarding the instrument.

2.9 The electrocardiogram of Thomas Lewis

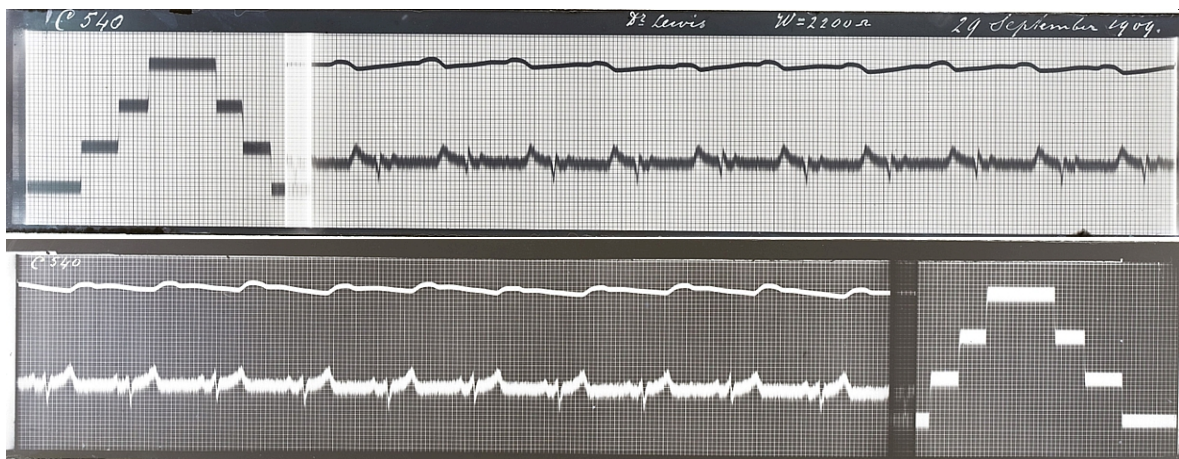

Figure 9: Carotid curve (upper tracing) and electrocardiogram (lower tracing) of Thomas Lewis, recorded by Einthoven on September 29, 1909. Two renderings of the same recording, read the upper panel from right to left.

In September 1909, Einthoven made a 1-lead ECG of Lewis (Figure 9). Later, Lewis re-recorded his ECG in London with the commercial string galvanometer manufactured by the Cambridge Company. Lewis wrote to Einthoven about the excellent reproducibility of his own 1-lead ECG, with only some tiny changes of the T wave compared the ECG made in Leiden [8].

2.10 The phonocardiogram

The string galvanometer was also used for recording cardiac sounds, transmitted from the chest with the funnel-shaped receiver of Berliner that conveyed the sounds via tubes to the microphone connected to the galvanometer's string [4]. In 1907 Einthoven presented a lecture about the third heart sound (see Figure 10) and its timing, duration, and clinical significance [10]. He assumed this sound was caused by a "second movement (thrill) of the valvulae semilunares of the aortic valve." He also mentioned that its presence was not unusual in healthy people. Today's opinion about the origin of this phenomenon includes the rapid inflow of blood from the left atrium into the left ventricle.

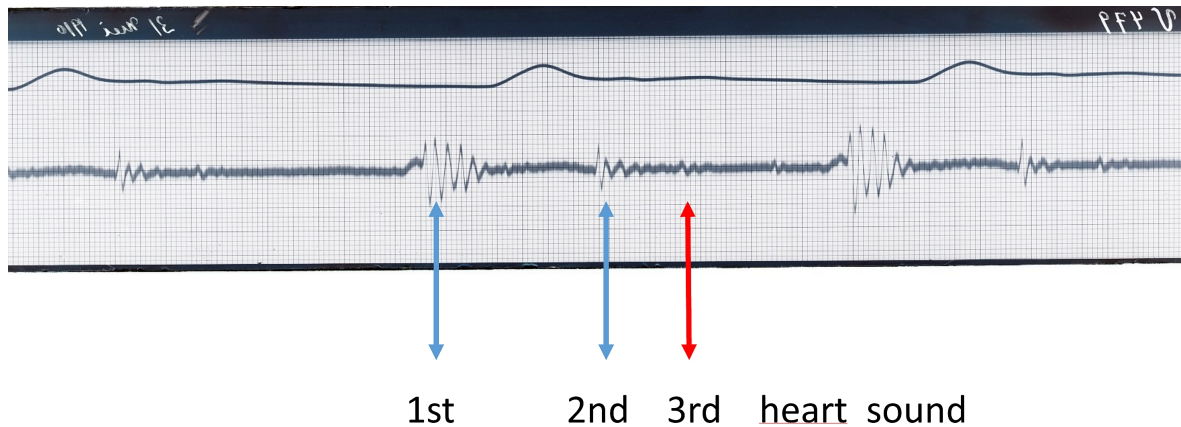

Figure 10: Carotid pulse and phonocardiogram as recorded by the string galvanometer on May 31, 1910, recording speed 200 mm/s. Note the presence of a third heart sound.

2.11 Simultaneous recording of the ECG and other physiological signals

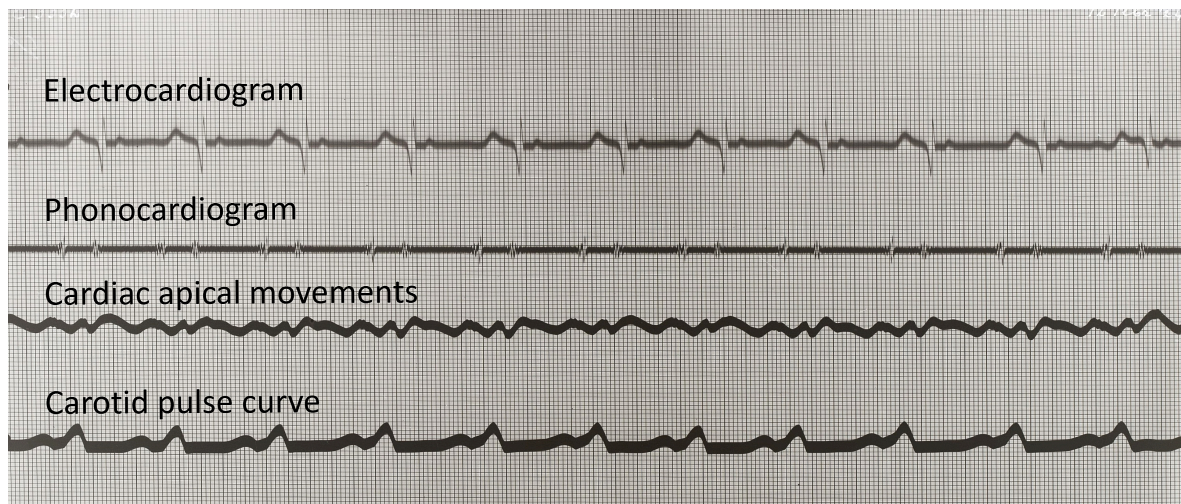

Figure 11: Simultaneous recording of an electrocardiogram, phonocardiogram, cardiac apical movements, and carotid pulse curve made on February 12, 1924. Read from right to left.

In the following years, the multichannel recordings were extended: the 1-lead ECG was recorded simultaneously with cardiac sounds, external movements of the cardiac apex, and the arterial carotid pulse. Figure 11 shows, top to bottom: an electrocardiogram with normal sinus rhythm, normal conduction times, normal P waves, and normal QRS complexes; the phonocardiogram with first and second heart sounds without murmurs; the curve of external apical cardiac movements (the so-called ictus cordis), and the carotid pulse curve. Recordings like the one shown in Figure 11 allowed for studying the relationships between

electrical and mechanical cardiac activity and their consequences for the circulation, topics that are still subjects of study nowadays.

2.12 Animal electrocardiography

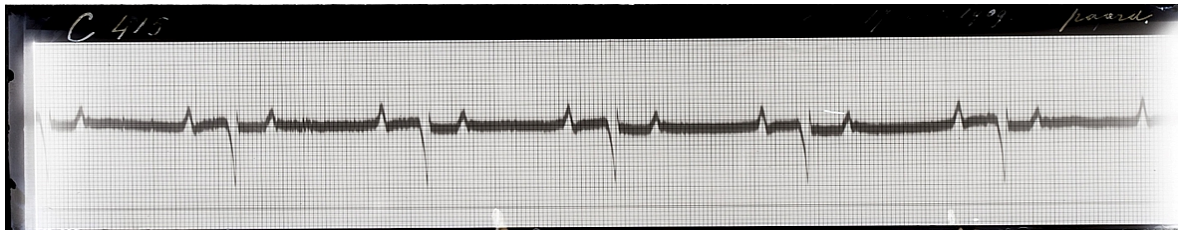

Figure 12: Electrocardiogram of a horse, recorded on May 7, 1909. Read from right to left.

Einthoven and coworkers also applied electrocardiography to dogs, rats, and horses. Figure 12 shows a single-lead ECG of a horse. The heart rate is about 30 beats per minute, with an atrioventricular conduction time of 220 ms. At rest, these values appear normal for horses. One can safely assume that keeping the horse standing quietly, the legs covered by cloths permeated with an electrolyte solution promoting skin conduction of the cardiac currents, was a big enterprise. Unfortunately, no photograph of this event is available, but a picture taken in his backyard garden in Leiden displays a small zoo built for his children; several animals, including a horse of limited height, were collected.

2.13 Vagal nerve activity, respiration and heart rate

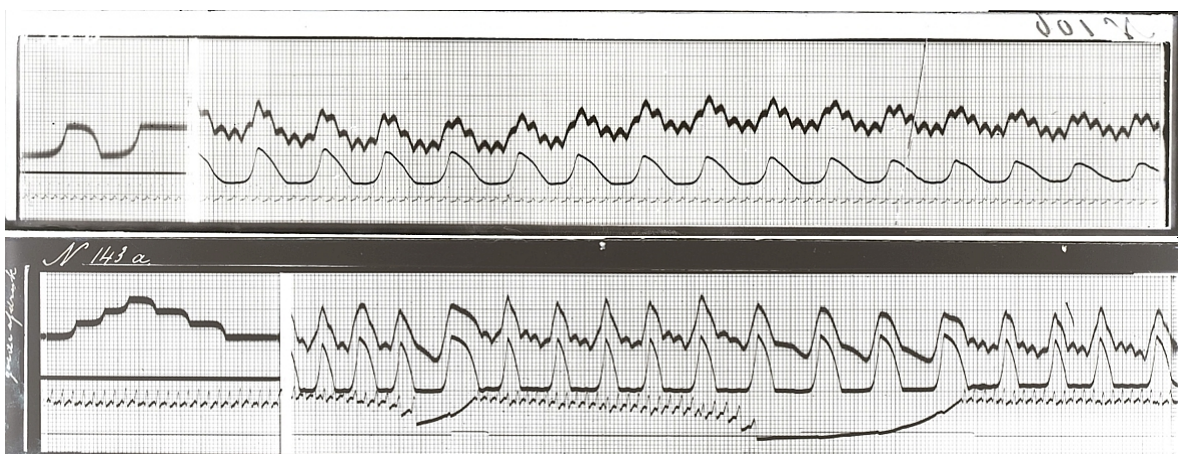

Figure 13: Upper and lower panels, from top to bottom: electrovagogram, pneumogram, and sphygmogram recorded in a dog, about 1908. Read from right to left.

Einthoven was also curious about the spontaneous action current of the vagal nerve and its relation to changes in heart rate and respiration depth and rate. Vagal endings in the aortic wall transmit centripetal information to the brain's vagal centrum, and these signals travel as action currents to the centrifugal vagal parts. The latter inhibit the cardiac rhythm and cardiac contraction. The combined recording of the vagal electrogram (called "electrovagogram" by Einthoven), pneumogram, and pulse curve offered the opportunity to study the influence of the vagal nerve [4, 11, 12]. Currently, the terms "centripetal" and "centrifugal" used by Einthoven and coworkers are replaced by afferent sensory and efferent parasympathetic nerve activity, respectively.

The upper panel of Figure 13 shows the electrovagogram, the pneumogram, and the sphygmogram as recorded in a dog. The slower deflections of the vagal nerve activity correspond to respiration, the faster ones to the cardiac beat. The lower panel depicts the effects of an intervention consisting of artificial respiration and vagal stimulation of the peripheral end of the vagal nerve. The fast fluctuations in the electrovagogram disappear, and a clear drop in blood pressure emerges. After stopping the intervention, the baseline conditions resume.

2.14 Effect of vagal stimulation

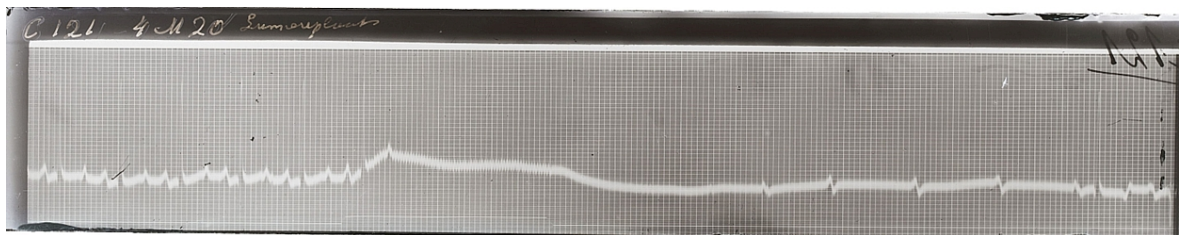

Figure 14: ECG changes after vagal stimulation by morphine in a dog (1904/5).

Figure 14 was recorded during a canine experiment. It shows the ECG changes after vagal stimulation with morphine: the electrical activity of the sinus node and the atria stopped entirely, followed by complete suppression of the atrioventricular conduction when sinus node activity gradually returned.

2.15 Time relationship between cardiac excitation and contraction

Significant and classical observations about the time relation between excitation and contraction of the heart were made by Dr. C.L. de Jongh and Einthoven [13–15]. These studies were done in the isolated, Langendorff-perfused rat heart. The perfusion fluid consisted of a modified Ringer solution. The specimen could survive from 15 minutes to many hours. One electrode was put on the left atrium to record the electrical signal of the atrium and the ventricle, the other on the apex of the ventricle to record movements of the ventricular muscle. Figure 15 shows that the onset of the ventricular contraction coincides with the onset of the

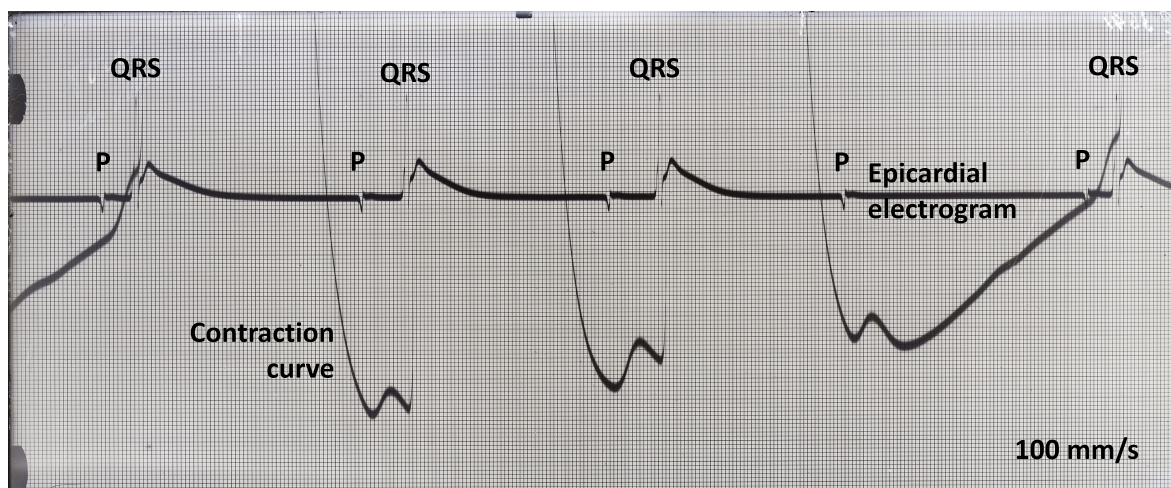

Figure 15: Combined recording of an epicardial electrogram and a cardiac contraction curve in the isolated Langendorff-perfused rat heart, February 1926.

QRS complex and, hence, that excitation and contraction of the heart are very closely linked in time. Of note, the recording in Figure 15 shows the so-called "Wenckebach periodicity" of atrioventricular conduction: the ultimate proof of this close time relation is yielded by the absence of coincidence of ventricular electrical activation and mechanical contraction when the QRS complex is absent.

In May 1920, in a scientific session of the Deutsche Physiologische Gesellschaft in Hamburg, Einthoven could demonstrate with these recordings that the ECG reflects the cardiac excitation wave and not the cardiac contraction wave and that both phenomena were closely related in time [4].

2.16 Radiographic recording

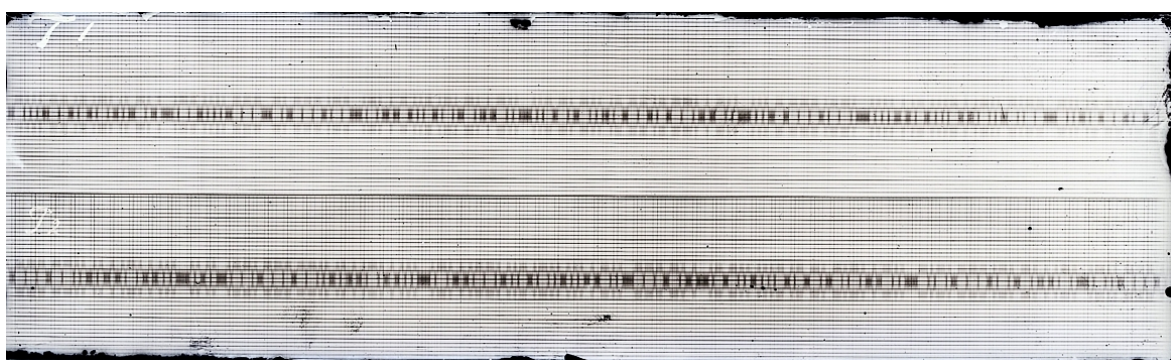

Figure 16: Vacuum string galvanometer recording of the first radiotelegram transmitted from Malabar, Indonesia, to Leiden, the Netherlands, over a distance of 12,000 km on January 13, 1923. Nota bene: the traces marked T1 and T2 are separate recordings.

Willem Einthoven and his son Willem Frederik, a brilliant electronic engineer, developed the vacuum string galvanometer [4]. This new galvanometer type allowed for the application of very thin strings that otherwise would be muffled in open-air conditions. The vacuum string galvanometer's purpose was to record weak and high-frequency action potentials of nerves, for example, the cervical sympathetic nerve [16]. Einthoven's son transported the new device to the former Dutch East Indies. He intended to test this device as an electric resonance instrument for the photographic recording of the transmitted (broadcasted) radio-telegrams from the Far East. This resulted in a glass string of 7 mm in length and a diameter of about 1 μm , with a resonance frequency of 40 kHz. That value matched exactly the broadcasting from the Far East with a wavelength of 7.5 km corresponding to a frequency of 40 kHz. The advantage of the galvanometer was the high-speed transmission, faster than the human ear or brain could manage. Actually, more than 600 words per minute could be transmitted 24 hrs/7 days because any human interaction could be avoided.

Figure 16 shows the first radio-telegram that was transmitted from Malabar, Indonesia, to Leiden, the Netherlands, over a distance of 12.000 km, on January 13, 1923. In addition to father and son Einthoven, Einthoven's chief mechanic, Mr. M.J. de Groot, was instrumental in realizing this high-tech application. He worked with Einthoven and his staff members for over 38 years [4].

3 Conclusions

This handful of photographic glass recordings shows the miscellaneous applications of the string galvanometer that was improved gradually after the first recordings in 1902. The recordings also emphasize the large variety of subjects explored by Einthoven and his fellows between 1894 to his death in 1927, facilitated by this device. The ECG was, above all, Einthoven's most important contribution to mankind that could not have been possible without the string galvanometer. Combined with other instruments, the Einthoven galvanometer emerged as the cornerstone for a better and broader understanding of many physiological processes and human physical disorders. We are very indebted to Einthoven's brilliant scientific and technical explorations that were rightly awarded the Nobel prize (1924).

References

- [1] W. Einthoven,
“Galvanometrische registratie van het menselijk electrocardiogram”,
Herinneringsbundel Prof. S.S.Rosenstein,
Eduard IJdo, Leiden, pp.101-106, 1902.
- [2] N.M. van Hemel, P.F.H.M. van Dessel and J.M.T. de Bakker,
The glass recordings of Willem Einthoven: a selection of electrocardiographic and other registrations made in the years 1894 -1931,
Bohn, Stafleu, van Loghum, Houten, 2019.
- [3] H.A. Snellen,
Willem Einthoven (1860-1927) Father of Electrocardiography, Life and Work, Ancestors and Contemporaries,
Kluwer Academic Publishers, Dordrecht, Boston, London, 1995.
- [4] A. de Waart,
Het levenswerk van Willem Einthoven 1860-1927,
Erven F. Bohn NV, Haarlem, 1957.
- [5] W. Einthoven,
“Le télécardiogramme”,
Archives Internationales de Physiologie, vol. 4, pp. 132-164, 1906.
- [6] W. Einthoven,
“Die galvanometrische Registrierung des menschlichen Electrocardiogramms, zugleich eine Beurteilung der Anwendung des Capillar-Electrometers in der Physiologie”,
Archiv für die gesamte Physiologie des Menschen und der Tiere, vol. 99, no. 9-10,
pp. 472-480, 1903.
<https://doi.org/10.1007/BF01811855>
- [7] W. Einthoven, F.L. Bergansius and J. Bijtel,
“Die gleichzeitige Registrierung elektrischer Erscheinungen mittels zwei oder mehr Galvanometer und ihre Anwenden auf die Elektrokardiographie”,
Pflügers Archiv für die gesamte Physiologie des Menschen und der Tiere, vol. 164,
no. 4-6, pp. 167-197, 1916.
doi: <https://doi.org/10.1007/BF01686453>
- [8] H.A. Snellen,
Two pioneers in electrocardiography. The correspondence between Einthoven and Lewis from 1908-1926,
Donker Academic Publications, Rotterdam, 1983.

- [9] D.M. Krikler,
“Thomas Lewis, a Father of modern cardiology”,
Heart, vol. 77, no. 2, pp. 102-103, 1997.
doi: <https://doi.org/10.1136/hrt.77.2.102>
- [10] W. Einthoven,
“Ein dritter Herzton”,
Archiv für die gesamte Physiologie des Menschen und der Tiere, vol. 120, no. 1-2,
pp. 31-43, 1907.
doi: <https://doi.org/10.1007/BF01677670>
- [11] W. Einthoven, A. Flohil and P.J.T.A. Battaerd,
“On vagus currents examined with the string galvanometer”,
Quarterly Journal of Experimental Physiology, vol. 1, no. 3, pp. 243-245. 1908.
<https://doi.org/10.1113/expphysiol.1908.sp000014>
- [12] W. Einthoven and J.H. Wieringa,
“Ungleichartige Vaguswirkungen auf das Herz, elektrokardiographisch untersucht”,
Pflügers Archiv für die gesamte Physiologie des Menschen und der Tiere, vol. 149,
no. 1-3, pp. 48-64, 1912.
doi: <https://doi.org/10.1007/BF01687008>
- [13] C.L. de Jongh,
“Die Zeitverhältnisse zwischen Elektro- und Mechanokardiogramm”,
Pflügers Archiv für die gesamte Physiologie des Menschen und der Tiere, vol. 213,
no. 1, pp. 216-237, 1926.
doi: <https://doi.org/10.1007/BF01733545>
- [14] W. Einthoven and F. Hugenholtz,
“Over het electrocardiogram bij het uitblijven van elke zichtbare samentrekking van het hart”,
Nederlands Tijdschrift voor Geneeskunde, vol. 63, no. 4, pp. 310-319, 1919.
- [15] W. Einthoven,
“The relation of mechanical and electrical phenomena of muscular contraction, with special reference to the cardiac muscle”,
The Harvey Society Lecturers 1924-1925, lecture Dec. 6, 1924, pp. 111-130,
J.B. Lippincott, Philadelphia, London, 1926.
- [16] J. Byrne and W. Einthoven,
“Functions of the cervical sympathetic manifested by its action currents”,
The American Journal of Physiology, vol. 65, no. 2, pp. 350-362, 1923.
doi: <https://doi.org/10.1152/ajplegacy.1923.65.2.350>

Eindhoven Lived Here

Peter van der Geer

Local Historian, Leiden, the Netherlands*

Abstract

During a period of twenty years (1896 – 1916), while working on his most significant accomplishments, Willem Einthoven lived with his family at the Rijnsburgerweg in Leiden. Research on Einthoven's correspondence so far has focused almost completely on his scientific work. A closer look at his private letters reveals some interesting facts that enrich his image of a soft-spoken scientist, balancing his time between lab work, lectures, faculty meetings, and conferences. First of all, Willem Einthoven was a family man, keeping strong ties with his brothers, cousins, wife, and children. Sound advice comes along with witty remarks and strong opinions. While he chose his words carefully to fight the anti-vivisection movement on official occasions, in his private letters one witnesses quite emotional outbursts. More than once, the British aroused his contempt, which even impacted his wardrobe. In the evenings and weekends, one could find him on the tennis court, at the local bikers club, or reading at Societeit Amicitia. Staying frequently at a small holiday house close to the sea (Noordwijkerhout), he sometimes went for a hunt in the dunes. Back at home, the couple invited professors and their wives for dinner or a short stay, including Einstein. In times of danger, during World War I and the Russian Revolution, they reached out to friends to help them with money, goods or shelter. The study of Willem Einthoven's private correspondence underpins the truth found in the words he spoke not long before he passed away: "I have always been in luck, at home, and in my work." In April 2022, at Rijnsburgerweg 23 in Leiden, Einthoven's home, a special commemorative sign was unveiled on the occasion of Leiden European City of Science 2022¹.

For 20 years he lived 300 meters from what is now the LUMC academic hospital: Willem Einthoven. His name and invention are well known, but what do we know about the man behind the scientist, more than what his obituary in the Times stated: "The man was as modest and simple as his genius."?

*Email: pmvandergeer@gmail.com

¹See www.rijnsburgerweg.nl/einthoven

1 Countless letters

Let's take a look at his correspondence, varying from isolated letters to long exchanges with persons and institutes. This would have been impossible without our former neighbor and your former colleague, the first cardiologist at this hospital, the late Herman Snellen, initiator of a series of Einthoven conferences. When he discovers that Einthoven's documentary archives are rapidly falling to dust he urges to digitize them. Thanks to him and Rijksmuseum Boerhaave, I have been able to read over 400 letters to and from his family, friends, and colleagues in fluent Dutch, German, English and French.

What can we read? He writes his son about a walk with Einstein in the Hortus discussing gravitation. We learn that on Thursdays he rents the local gym with some friends to play tennis. That he just bought a permit to go hunting and proudly mentions that has shot six large seagulls in the dunes.

2 Not an easy start

Reading his correspondence is also a tour of his scientific career. Einthoven's start isn't easy. Arriving in Leiden in 1886, for the first ten years Willem Einthoven and his wife have to look twice at every penny. Not voluntarily! He is a professor with a student debt. Why? The government has paid his medical studies on the condition to serve eight years as an army doctor in the Dutch Indies. Being only 25 years old and choosing to become a professor instead, the government requires him to return 6,000 guilders (equivalent of 86,000 euros nowadays). One discovers his rhetorical talent developed as a member of the rhetorical society Bellamy in Utrecht, when he fiercely opposes in his letter to the government officials: "As a scientist, my contribution to new medical treatments may yield multiple returns on your investment." The government said no.

3 New neighborhood

Ten years later, the family moves from the crowded city center to a large house at the Rijnsburgerweg. Early 1900 this is the place to be. From the new houses along this centuries-old road one has splendid views over the green meadows on both sides. Here, the water is clear compared to city canals that can take every color the industry used to paint their textiles. On the horizon, one does not see factory chimneys but the castle towers of Oud Poelgeest and Endegeest. His neighbors in those days remember Einthoven making his evening strolls along the 2-kilometer green alley.

Who are his neighbors? Take a look at the picture made at the Noble Prize Dinner of the Medical Faculty in 1925 (see Figure 1). More than half of the dinner guests – the famous Barge, Jelgersma, Kuenen – are living next door in those early years. With another



Figure 1: Guests at Medical-Faculty dinner 1925, honoring Einthoven for the Noble Prize.
Source: Academic Historical Museum Leiden

neighbor, director of the largest local distillery, Jacobus Hartevelt, he discusses strategies for how to win a game of whist (a popular predecessor of bridge). And the striking portrait of Einthoven in the Academic Building is painted in 1924 by his former neighbor Adolf van Dijk (see Figure 2).

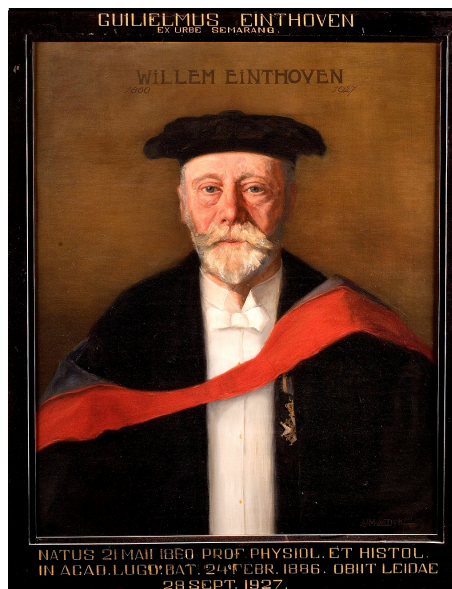

Figure 2: Portrait of Einthoven in the Academy Building, Rapenburg, Leiden. Source: Leiden University, <http://hdl.handle.net/1887.1/item:1581805>

We have a picture of the family (Figure 3). They have beautiful names like Louise Marie Mathilde Caroline, just called Wies. On Einthoven's travels he writes many letters to his wife Frederique, just called Loekie. When he has to leave for a trip to St. Petersburg, taking the

boat from Rotterdam on an early Monday morning, he writes her later that the departure was so much delayed that he considered returning to Leiden briefly to fetch another kiss from her.



Figure 3: Family portrait in the back garden of their house at Terweepark on Rijnsburgerweg, Leiden. Source: Collection Einthoven family

He enjoys writing to his daughters, not just asking about their studies but also telling them about the president of the British Royal Society who had forgotten their father's name when introducing him, or about an esteemed guest sleeping during his speech, and another one that considered the dinner much easier to digest than his lecture.

4 Strong opinions

Reading his letters to his brothers, we discover Einthoven as a man with also some strong opinions: "Put them against the wall, beat them up, make them loose this war ..." It's 1900, and the second Boerenoorlog is going on in South Africa. He's fulminating against the "shabby" English imperialists with their army of 221,000 soldiers ready "to eliminate" the Boeren (descendants of Dutch colonists). Einthoven tells his brother that he fights his own little war. And indeed, there's this letter to his tailor, the famous Domhoff in Rotterdam, also working for the royals: "Every fabric is fine, as long as it's not made in England."

His contempt for the English is profound, also for another reason. Reporting from a physiological conference in England, he writes: "The repugnant hypocrisy of the English people, who now mistreat women and children of our related Boeren family, is in my view no more apparent than through their partly morbid, partly hypocritical tenderness towards dogs, rabbits, and frogs." It is the time of the Brown Dog Affair, the dog that gets a statue

in London, marking the victory of the British anti-vivisection movement. From that time, every scientist in England using animals for research needs to have a permit. Also in his lectures in Leiden, as Einthoven writes, he discovers that (mainly female) students question the practice of vivisection. Their professor has very clear thoughts on this: "Once these girls have become mothers, they won't make a fuss about rabbits because they only care for their kids." It would be nice to know whether his own daughters would agree with him?

Meanwhile a Belgian delegation wants to visit his physiology lab, which was a true place of pilgrimage in those days. Unfortunately, they can't find it and ask a police officer, an anecdote he describes for his family.

Belgians: "Sir, can you tell us where we can find the physiological lab".

"The what?" asked the policeman.

Belgians: "Well, you know, where they kill dogs, rabbits and monkeys..."

"Just around the corner, gentlemen," he answered.

Einthoven, keeping a small zoo with even horses next to his lab, was certainly aware of the possible switch in the public opinion on vivisection in the Netherlands. To secure his research, he starts lobbying against any further regulation – even writing speeches for parliamentarians.

You might think now that Einthoven suffered from Anglophobia. Almost the opposite was true. He corresponds with close English colleagues like Thomas Lewis and John Berry Haycraft for over twenty years and with Augustus Waller for over thirty years, also exchanging family matters. He even admits to them that the Dutch support for the Boeren is due to "racial sympathy" (in the sense of cognate sympathy), concluding: "We better talk about science and friendship, not politics."

5 Generous

Back to the family. Once you have learned to look twice at every penny, you keep on doing this. We find Einthoven arguing with his life insurance company over the annual premium ..., taking the cheapest hut on the boat to Edinburgh, but by no means Einthoven was stingy. For holidays they rent a little house close to the sea. He lends 500 guilders to Ehrenfest, who had just arrived from Russia. When a colleague helps his wife with a small clinical operation, he insists on paying for this service. At Christmas, the family sends large boxes of chocolates to their friends overseas. A children's party at his house counts 53 kids, drinking lemonade and eating cakes. Another time, his son complains about his stomach because of the sour brown government bread they have for breakfast.

In 1907, the family moves for still unknown reasons to the other side of the street, Rijnsburgerweg 23 (Figure 4). For sure, the rent is considerably higher. This Jugendstil house is just finished by two trendy architects in those years, Jesse and Fontein, famous for their villas.

Modest as Einthoven is, he continues writing his friends who prepare to come to Leiden, that “we live very simply. I fear we have not so much comfort as you’re accustomed to at home.” One might consider this false modesty, but it’s also a matter of expectation management. The Einthovens frequently invite professors from England, Germany, and Russia. They are all impressed by their friendly hospitality and according to Samojloff “das schöne moralische Klima” at their home. They also have Einstein for dinner. Sitting at the table, his daughters are not so much impressed by his genius, but more surprised by his lack of table manners.



Figure 4: Unveiling of a plaque, April 12, 2022 at Einthoven’s house on Rijnsburgerweg 23, Leiden. Picture by Myriam Vander Stichele

6 Bike fever

We learn from the letters that Einthoven suffers from hypertension, which often keeps him from the lab. His troubles with Kamerlingh Onnes on organizing a quiet lab space do not help of course. Einthoven wrote: “More and more I learn how to manage myself in the faculty meeting.” It doesn’t make him lose his sense of humor, stating that he suffers from another Dutch disease that he named ‘rijwielkoorts’ (i.e. bike fever). With his precision brain he records one day that he cycled 50.9 km at an average speed of 14 km per hour to Utrecht.

So far, this brief and anecdotal insight in his correspondence illustrates what Einthoven himself concluded at the end of his life: “I have always been in luck, at home and in my work.” Further research will reveal more about the character and worldview of this noble man, whose discoveries still impress, but who still lacks a complete biography.

References

For this article the author researched the collection of Einthoven’s correspondence at the Rijksmuseum Boerhaave Collectie: L-LdnRAL_AR-2007_1 to 237.

The Bright Future of Clinical Technology and Technical Medicine

Roderick W.C. Scherptong

Cardiology Department, Leiden University Medical Center, the Netherlands

Faculty of Mechanical, Maritime and Materials Engineering, Delft University of Technology,
the Netherlands

Abstract

Willem Einthoven was trained as a medical doctor and became a professor of physiology and histology at Leiden University. Although not designated as such at that time, the development of ‘clinical technology’ was at the core of his research. Einthoven had medical questions and intended to use technology to find answers. Due to his skills in medicine and physics he could develop the string galvanometer and implement this technology in clinical practice. This unique combination of medical knowledge and engineering skills was unprecedented in cardiology (in those days internal medicine) and not frequently seen at such a high level thereafter. Clinical technology and medical practice have developed into two distinct and complex fields of knowledge. Therefore, professionals tend to focus on either technical or medical aspects of (cardiovascular) disease. Although these domains are overlapping, both have dedicated educational programs, professional associations, and even the scientific literature of engineers and medical doctors is dispersed to some extent. As a result, medical problems may not find an optimal route toward a technological solution if collaboration between professionals from both fields is insufficient. To overcome this issue, a dedicated educational program was developed in the Netherlands. The program, named ‘bachelor clinical technology’ and ‘master technical medicine,’ provides professionals with medical and engineering competences at an academic level so that they can bridge the gap between these domains and, thus, can optimize the implementation of technology in clinical practice. In this paper the historical context, curriculum, and results of this educational program are reviewed.

1 Introduction

Willem Einthoven was trained as a medical doctor in Utrecht. During his education, he, amongst others, developed a profound interest in physics [1]. Therefore, he decided to follow

classes of well-known physicists such as Buys Ballot to acquire knowledge in this field [1]. After being appointed a professorship at the medical faculty of the Leiden university, Einthoven developed an interest in the electrophysiology of the heart. He was convinced that in order to cure cardiovascular disease, it was essential to understand heart function and the mechanisms behind numerous types of diseases [2]. And, in order to do so, he organized a team of medical doctors and engineers to develop a string galvanometer that could be used in clinical practice to record the electrocardiogram [2]. Einthoven himself was the orchestrator within this collaboration and used his knowledge from both domains to ensure that all professionals on his team had the proper input. For Einthoven, the ultimate goal of this collaboration was clear and well-described: to characterize and cure cardiac disease [2].

The example above illustrates which ‘human resources’ and training background are required to come to technological innovations. Just the presence of medical doctors and engineers in the field of medical technology is insufficient to come to safe and effective solutions. A professional in between, like Willem Einthoven, who has medical as well as technical expertise, can be tremendously helpful in that context. In the current era it is quite common that professionals are sub-specialized and have very specific knowledge and skills. This occurs in medicine as well as engineering. Whereas many medical professionals are trained to treat a specific sub-set of diseases, engineers tend to be specialized in a sub-part of the technological development process. It is frequently observed that such sub-specialization results in a gap between the engineers who developed (parts of) the technology and the professionals who use it in clinical practice [3].

To solve this issue, the University of Twente introduced an educational program aimed at professionals that can close the gap between medical doctors and engineers, thus contributing to the development and implementation of safe and effective medical technology [4]. The program, called Technical Medicine, was started in 2003 at the University of Twente. In 2014, a similar educational program was launched as a collaborative initiative from the Leiden University Medical Center, the Erasmus Medical Center Rotterdam, and the Delft University of Technology. The bachelor phase of this program was named ‘Clinical Technology’ and the master phase was called ‘Technical Medicine’. This review shortly reflects on the background and set-up of this curriculum. In addition, the contribution of this new group of professionals to the field of medical technology is discussed. An extensive review of the educational program of the University of Twente, including the scientific background, was published by Groenier et al. [4].

2 The med-tech gap

Medical technology is a quickly expanding domain and one of the important driving forces behind progress in healthcare. Technologies are available to improve population medicine, but also on a highly-patient specific level. It is being used by patients at home and by highly

trained medical professionals within specialized operating theaters. However, when it comes to development and implementation of technology, the domains of the engineer and the medical professional are still separated. Both have dedicated educational programs that focus on domain-specific competences. Each group has its own professional associations and the scientific literature on engineering and medicine are dispersed [4]. Although much overlap exists, a well-described, optimal level of collaboration between medical experts and engineers surrounding the development and implementation of technology does not exist. This gap between the medical domain and technical domain introduces certain risks, such as development failures, inappropriate use of technology, and missed opportunities for future developments [4].

It was noted that most medical experts have limited knowledge of technology development and associated safety aspects, since their training was primarily aimed at understanding and treating disease. Furthermore, although the clinical application of current medical technologies is usually clearly identified, most medical educational programs lack engineering courses. On the other hand, since the educational program of engineers is provided by technical universities, the exposure to clinically applied technology within the medical context is also limited. The technical medicine educational program was introduced to address this issue [4].

Within the Medical Delta, it was decided to host the program by both medical as well as technical faculties to provide future professionals with the right combination of competences from both domains. These professionals should be characterized by a medical-technical mindset equipped to connect medical problems safely to effective technological solutions.

3 The medical-technical curriculum

The Medical Delta is an extensive collaboration that incorporates the universities and colleges of Leiden, the Hague, Delft, and Rotterdam. It includes the Delft University of Technology, the Erasmus Medical Center of Rotterdam, and the Leiden University Medical Center. These three partners decided to collaborate on designing a hybrid educational program that provided students with fundamental engineering courses at the technical university, clinical training at both medical centers, and combined where appropriate. The full curriculum exists of a three-year bachelor's and a three-year master's educational program (Figure 1).

The bachelor's program encompasses a three-year curriculum in which the students follow separate medical, technical, and tech-med integration courses (see Figure 1A). During the medical courses, the physiology and pathology of the different organ systems are discussed. To ensure that students understand the application of technology within the right medical context, complex organ systems are discussed twice, once in the first and once in the second year of the program. Next to medical subjects, technical subjects such as math, bio-informatics, signal processing, medical imaging techniques, and computer simulation

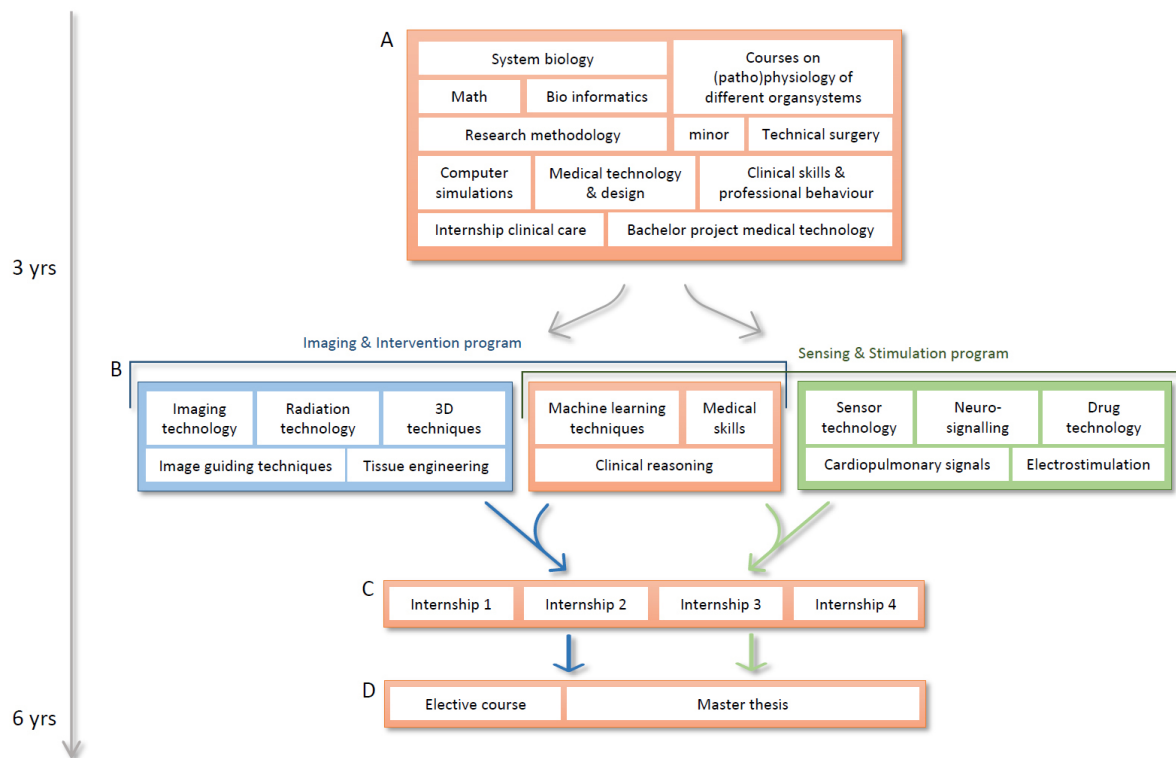

Figure 1: Overview of the curriculum. This image shows examples of the courses students follow during the bachelor (A) and the master program (B/C/D).

are discussed in dedicated courses. Depending on the context, integration between the medical and technical domains is discussed within the courses or in separate courses such as ‘Technical surgery’ or ‘Medical technology & design’ that specifically focus on this issue. Students finalize the bachelor part of the study program with a clinical technology project in which the students are asked to help develop a technological solution for a problem coming from medical practice.

The master’s program has a three-year curriculum in which the students follow courses, do clinical internships, and, finally, write a master’s thesis (see Figure 1B/C/D). Depending on their personal interest, students either follow the Imaging & Intervention or the Sensing & Stimulation track (see Figure 1B). Students that follow the first track will develop to become technical imaging specialists. In-depth courses about the technology and application of all currently used imaging modalities are offered, and students are taught the essentials of development within the field of medical imaging (see Figure 1B, blue). Students that do the Sensing & Stimulation track are trained to become specialists in these fields. These students follow courses on sensor-technology in the broadest sense, both within as well as outside the hospital setting and from nanotechnology to population medicine (see Figure 1B, green). All students follow general medical-technical courses (see Figure 1B, orange). During the second year of the master’s program (see Figure 1C), the students do medical-

technical internships during which they join daily clinical practice and, simultaneously, do a short technology implementation or development project at a medical department. The internship can be selected from a list that covers both Imaging & Intervention and Sensing & Stimulation subjects at different levels. This way, students can assemble an internship program that matches their personal interest and adds to their professional profile. In the last year, students do an elective course and they finalize the study by writing a master thesis that is focused on the analysis, implementation or development of medical technology within a specific context (see Figure 1D).

Throughout the curriculum (bachelor's and master's), courses are offered that aim at building general medical and technical competences. During these courses, medical subjects such as clinical reasoning and practical skills are offered. Furthermore, students build a scientific set of skills to be able to assess and perform research in both the technical as well as the medical domain. In addition, students are specifically trained to do risk analysis, efficacy assessment and value determination of modern technology. Finally, general engineering skills such as computer programming, artificial intelligence application, and technology development are taught in dedicated courses. The level of these courses is adjusted to the timing within the program and the complexity increases during the curriculum.

4 The bright future of technical medicine

In 2009 the first students graduated from the University of Twente, and at the same time the professional association of technical physicians (NVvTG) was founded. Since then, more than five hundred graduates have entered the healthcare field. Detailed data on the employment of these new professionals is currently lacking. In 2021, the NVvTG performed a survey among its members to acquire information about this topic [5]. This survey showed that around 60% of the respondents (n=169), was working in a hospital (university 42%, general 19%), 16% had a position at a university, and 18% in an enterprise. The type of professional activities performed was reported to be variable, however, it clearly reflected the profiles of both master tracks (Imaging & Intervention and Sensing & Stimulation; see Table 1). Slightly less than half of the respondents indicated performing clinical tasks. More than 80% of the respondents either finished (30%) or was in the process of writing a PhD thesis.

The Dutch government recognized the contribution of technical medicine specialists and certifies Technical Medicine graduates to treat patients under the title 'Clinical Technologist' [6]. Dedicated legislation defines which pre-specified parts of the treatment of individual patients clinical technologists can perform. In order to do so, graduates have to be officially registered. Analogous to the number of professionals that indicates to perform clinical tasks, slightly less than half of the professionals is registered as such.

Not surprisingly, no studies currently exist that describe the employment of clinical tech-

Table 1: Type of professional activities performed. In a survey, professionals were asked to indicate in which sub-field of healthcare they were active. Multiple answers per respondent were permitted to gather the full professional profile [5].

Professional activity	Respondents active in that field
Medical imaging	62 %
Sensing & stimulation	52 %
Artificial intelligence	38 %
Telemonitoring	24 %
Ionizing radiation and radio pharmacy	22 %
(Robot) Navigation technology	17 %
3D Printing	17 %
ICT/eHealth	6 %
Endoscopy	5 %

nologists or technical physicians within the cardiovascular domain. Nonetheless, the potential of this group of professionals is large. The diagnosis, treatment, and follow-up of patients with cardiovascular disease increasingly rely on technology. In addition, future ambitions as described by professional associations also pinpoint technological development as a pivotal element in facing the challenges of cardiovascular disease [7]. However, it is simultaneously noted that adoption of new technology, such as eHealth, by cardiologists can be slower than anticipated, which usually has a complex and multifactorial origin [8]. Potentially, medical-technical specialists can expedite such processes since they, by training, have fundamental knowledge of disease and are equipped to quickly assess new technologies by weighing advantages and drawbacks. In addition, due to their multidisciplinary background these professionals can engage in effective communication between both medical professionals as well as engineers to guide implementation and development processes.

The definitive role of technical physicians and clinical technologists in cardiology, as well as other specialties in medicine, still has to be demonstrated. Experience from other medical specialties can be used to understand how these professionals are likely to fit within the cardiovascular domain. E.g., in nuclear medicine, the expanding role of technical physicians in the Netherlands was already described, including the perspectives for the near future [9]. Most is determined by the existing medical context, technical profile and personal interest, as demonstrated in Figure 2. E.g., the contribution of a technical physician within a heart failure clinic setting is likely to be aimed at remote monitoring, application of artificial intelligence, patient safety and value assessment. Another likely variant would be a professional who plays a central role in the development and implementation of image guiding tools for cardiac interventions, which would require experience in 3D modeling, ICT, and artificial intelligence. These examples illustrate the value of engineering competences in the

quest to solve medical problems by using modern technology. In addition, it stresses the importance of a medical-technical curriculum that provides students with sufficient flexibility to create a profile that fits both their personal interest as well as the demands from medical (and technical) practice.

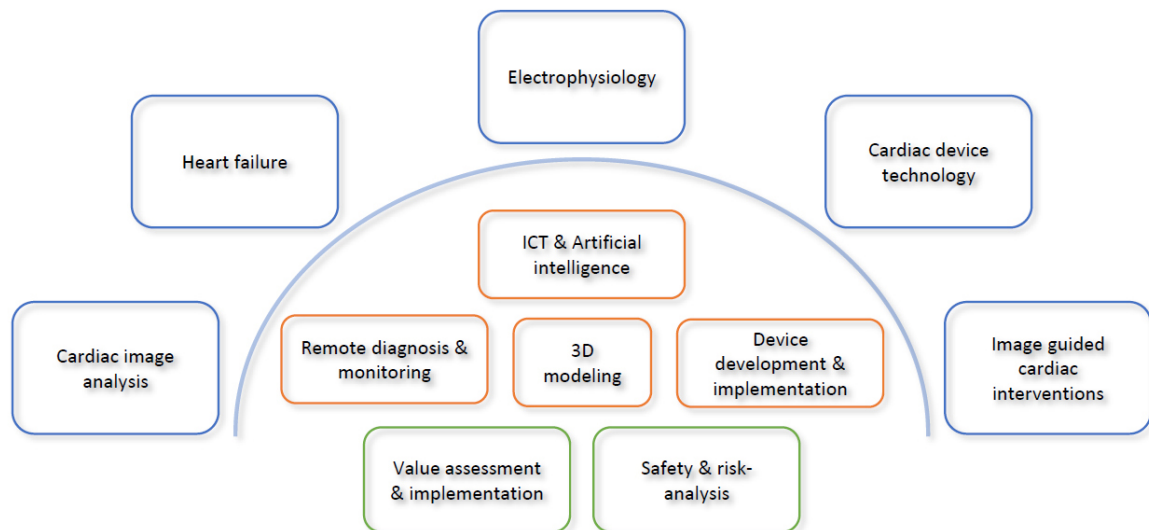

Figure 2: Potential areas of expertise within the cardiovascular domain. The overview shows examples of cardiac subjects with a medical nature (blue) and current subjects from the technical domain (orange, green). Technical physicians and clinical technologists are likely to create a specific profile through the combination of medical and technical subjects from the cardiovascular domain.

5 Conclusion

More than a hundred years ago, Einthoven demonstrated that technology was an essential tool for the understanding of pathophysiology. Due to his hybrid personal training and focus on cardiac disease, he could assemble the right group of technical and medical professionals to develop and demonstrate the value of the string galvanometer. The development of modern technology is much alike and requires knowledge and skills from the medical as well as technical domain's. The curriculum of the bachelor's clinical technology and master's technical medicine provides future professionals with the appropriate combination of knowledge and skills to propel the development and implementation of medical technology. Although the definitive role of technical physicians and clinical technologists has to be determined, this new group of professionals with a dedicated medical-technical profile has potential within the cardiovascular disease domain.

References

- [1] *Willem Einthoven – Biographical. NobelPrize.org. Nobel Prize Outreach AB 2022*, Wed. 27 July 2022.
<https://www.nobelprize.org/prizes/medicine/1924/einthoven/biographical>
- [2] W. Einthoven,
"Het tele-cardiogram",
Nederlands Tijdschrift voor Geneeskunde, vol. 50, pp. 1517-47, 1906.
<https://www.ntvg.nl/artikelen/het-tele-cardiogram>
- [3] *Medical devices: managing the mismatch; an outcome of the priority medical devices project*,
WHO Press, Geneva, 2010.
ISBN: 9789241564045; <https://apps.who.int/iris/handle/10665/44407>
- [4] M. Groenier, J.M. Pieters and H.A.T. Miedema,
"Technical Medicine: Designing Medical Technological Solutions for Improved Health Care,"
Medical Science Educator, vol. 27, pp. 621-31, 2017.
doi: <http://dx.doi.org/10.1007/s40670-017-0443-z>
- [5] T. Boers and T. van Steenbergen,
"Nieuwe loot aan de stam", (in Dutch)
Medisch Contact, theme issue, pp.10-11, 2021.
<https://www.medischcontact.nl/nieuws/laatste-nieuws/artikel/nieuwe-loot-aan-de-stam.htm>
- [6] "Wet op beroepen in de individuele gezondheidszorg,"
<https://wetten.overheid.nl/BWBR0006251/2022-04-01>
- [7] I. Frederix, E.G. Caiani, P. Dendale, et al.,
"ESC e-Cardiology Working Group Position Paper: Overcoming challenges in digital health implementation in cardiovascular medicine,"
European Journal of Preventive Cardiology, vol.11, pp. 1166-77, 2019.
doi: <https://doi.org/10.1177/2047487319832394>
- [8] R.W. Treskes, T.X. Wildbergh, M.J. SchaliJ and R.W.C. Scherptong,
"Expectations and perceived barriers to widespread implementation of e-Health in cardiology practice: Results from a national survey in the Netherlands,"
Netherlands Heart Journal, vol. 27, pp. 18-23, 2018.
doi: <https://doi.org/10.1007/s12471-018-1199-9>

- [9] R.H.J.A. Slart and L. De Geus-Oei,
“A New Colleague in Nuclear Medicine, the Clinical Technologist: Quo Vadis?”
European Journal of Nuclear Medicine and Molecular Imaging, vol. 49, pp. 3012-
3015, 2022.
doi: <https://doi.org/10.1007/s00259-022-05789-7>

Electrocardiographic Imaging: History, Applications, and Future Perspectives

Job Stoks* and Matthijs Cluitmans†

* Department of Cardiology, Maastricht University Medical Center+, the Netherlands
Department of Advanced Computing Sciences, Maastricht University, the Netherlands
BIOMED, Hasselt University, Belgium

† Department of Cardiology, Maastricht University Medical Center+, the Netherlands

Abstract

Electrocardiographic imaging (ECGI) is a noninvasive modality that reconstructs electrical activity at the heart level from a patient-specific body-surface potential map and heart geometry obtained by medical imaging. Here, we describe its history, advantages and challenges, validation studies, state-of-the-art applications, and future directions. Briefly, ECGI provides a trade-off between the noninvasive low-resolution electrocardiogram (ECG) and invasive high-density contact catheter mapping. Even though ECGI comes with its intrinsic challenges, most validation studies show a moderate-to-good accuracy and ECGI yields anatomy-based insights that the ECG cannot provide. Most ECGI applications currently bring value in a research setting. This includes investigating disease mechanisms, optimizing cardiac resynchronization therapy, identifying arrhythmogenic substrate, and multi-modality imaging. For clinical adoption, further maturation is still required in terms of standardization, ease of use, and external validation of study results. Its ultimate potential may lie not only in investigating disease mechanisms and providing risk stratification for future arrhythmic events but most likely also in obtaining personalized insights through the integration of ECGI with other clinical modalities.

1 Introduction

Electrocardiographic imaging (ECGI) is a noninvasive modality that reconstructs electrical activity at the heart from a body-surface potential map (BSPM) and patient-specific heart geometry, see Figure 1. This allows to study the heart's electrophysiological properties non-invasively, including its activation and recovery sequence. Typically, the heart geometry is imaged through a computed tomography (CT) scan or magnetic resonance imaging (MRI).

The BSPM is acquired through a dense array of electrodes attached to the torso, typically detected through MRI, CT, or a three-dimensional camera. Combined, this yields the three-dimensional relationship between the electrodes and the heart geometry. This then allows calculating the electrical activity of the heart by solving the “inverse problem of electrocardiography” [1]. Many implementations of ECGI exist, amongst which methods to directly estimate activation times or transmural voltages [2]. However, the most widely used implementation of ECGI is the so-called potential-based formulation of ECGI. This approach estimates potentials on the ventricular or atrial surface and will be the focus of this article. First, we address the history of ECGI. Thereafter, we address the mathematical, physiological, and experimental challenges in ECGI. Furthermore, we discuss the current state-of-the-art and future applications of ECGI.

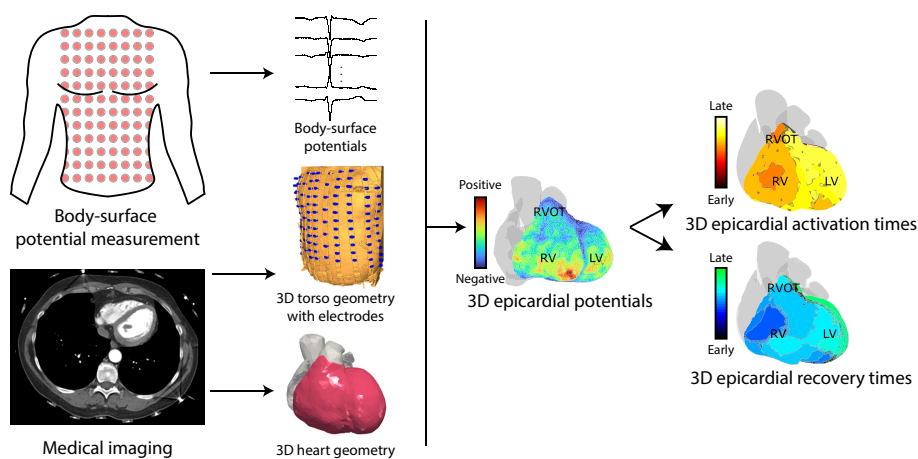

Figure 1: Electrocardiographic imaging (ECGI). Body-surface potential recordings and a medical imaging scan are combined in a torso-heart geometry. Epicardial potentials are reconstructed from the body-surface ECGs and yield local electrograms, activation isochrones, and recovery isochrones.

2 Background and history of ECGI

Since the late 1700s, many scientists have tried to study the heart’s electrical activity in great detail. After the development of the three-leaded electrocardiogram (ECG) by Dr. Willem Einthoven, Drs. Wilson and Goldberger added more leads to the ECG, eventually giving rise to the clinical 12-lead ECG [1]. The 12-lead ECG is still in widespread use and remains the cornerstone of clinical electrocardiology. However, even though the 12-lead ECG is easy to use and can identify many kinds of cardiac pathologies with either electrical causes or consequences, it has limited spatial resolution: i.e., it is difficult to localize abnormalities in detailed regions of the heart. For this reason, from the late 1960s onwards, researchers started using tens to hundreds of electrodes to investigate BSPMs (see Figure 2) [1]. Even

though these BSPMs provide more detail about the heart’s electrical activity than the 12-lead ECG, they are less easy to use and require specific equipment, knowledge, and time. Moreover, analyses that are confined to the body surface only allow to study the heart from a distance, through signals that are attenuated and dispersed by the conducting torso volume. At the other end of the spectrum, contact catheter mapping with an electrode catheter applied to the heart’s inner or outer surface allows to directly measure the heart’s electrical activity. Contact catheter mapping is highly accurate and could count as a golden standard for electrical signals. Moreover, it allows direct catheter-based intervention, e.g. by applying ablation to terminate arrhythmias. However, these measurements are invasive, come with risks of dangerous complications, and are time-consuming and costly (Figure 2). Moreover, contact mapping requires the point-by-point measurement of individual electrograms, meaning that typically only a small portion of the heart can be measured in one beat, rendering beat-to-beat variability complex to investigate.

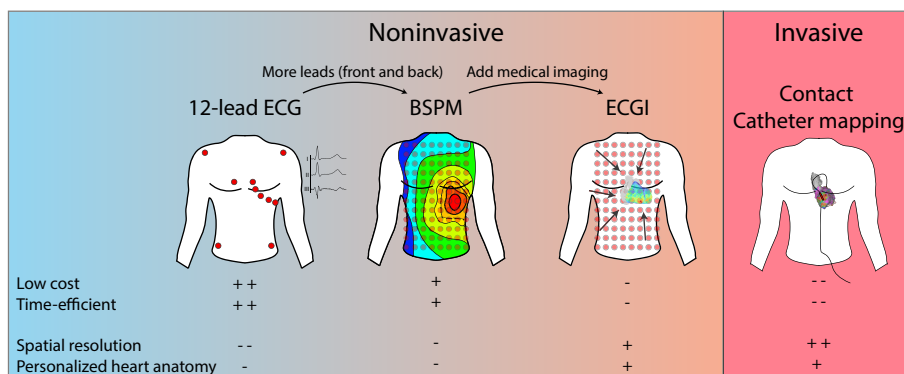

Figure 2: Comparison of the clinical 12-lead electrocardiogram (ECG), body-surface potential measurement (BSPM), electrocardiographic imaging (ECGI), and invasive contact catheter mapping. The first three modalities are noninvasive, and the latter is invasive. A BSPM can be obtained by adding additional leads to the 12-lead ECG, and ECGI can be performed by further adding medical imaging and calculating the inverse reconstruction. Each method comes with its own advantages and disadvantages, listed below. + indicates positive properties (cheap, time-efficient, etc.) while – indicates negative properties (expensive, time-consuming etc.)

In search of an optimal trade-off between the detailed information that contact mapping provides and the noninvasive character of body-surface measurements, ECGI was developed (Figures 1 and 2). Through a BSPM and a known torso-to-heart geometrical relationship, cardiac electrical activity can be reconstructed by solving the so-called “ill-posed inverse problem of electrocardiography” [1]. ECGI was first investigated through mathematical models, focusing on a spherical surface, investigating the basic mathematical requirements such as constraining the solution [3], and whether the technical estimation of cardiac po-

tentials would be feasible with respect to noise [4]. Later on, more realistic and complex scenarios were investigated and tested in dogs [5], [6]. Moreover, validation studies using clinically interesting outcomes [7] eventually led to the first real-life application in humans [8]. Initial studies were limited to the ventricles, but later, the atria also became an active field of research. Nowadays, ECGI is still actively being improved [9], but is also widely applied in both the research and clinical domains.

3 Challenges in ECGI

ECGI's main disadvantage in comparison to invasive contact catheter mapping (see Figure 2) is its accuracy, estimated to be around 10mm (see Table 1). Increasing ECGI's accuracy is still an active field of research and comes with its own challenges. These can be divided into mathematical, physiological, validation, and standardization challenges, which we will now address. See Figure 3 for an overview.

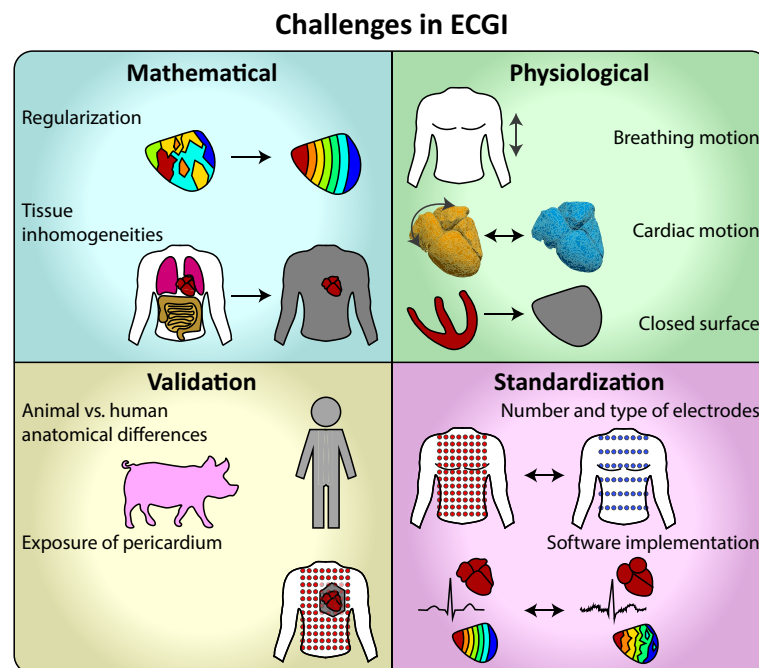

Figure 3: Challenges in ECGI. Challenges can be divided into mathematical, physiological, validation and standardization challenges. See text for further explanation.

3.1 Mathematical

Mathematically, the forward problem of electrocardiography is formulated as

$$\Phi_B(t) = \mathbf{A} \cdot \Phi_H(t) \quad (1)$$

where $\Phi_H(t)$ represents the potentials on the heart as a function of time, $\Phi_B(t)$ the potentials on the body surface as a function of time, and \mathbf{A} the transfer matrix which captures the geometrical and electrical relationship between the heart and body surface.

The inverse problem of electrocardiography is intrinsically ill-posed, meaning that even if the transfer matrix \mathbf{A} is invertible, the mathematical solution for potentials on the heart $\Phi_H(t)$ is sensitive to noise, and a small perturbation of body-surface signals $\Phi_B(t)$ can lead to a disproportionately large change in the solution [1]. For this reason, the solution needs to be constrained, based on knowledge of the physiology and physics of the heart's electrical activity. This leads to a mathematical frame in which the solution should be found and is termed 'regularization'. Commonly, a zeroth-, first-, or second-order Tikhonov regularization [10] is used,

$$\hat{\Phi}_H(t) = \min_{\Phi_H(t)} \{ \|\mathbf{A} \cdot \Phi_H(t) - \Phi_B(t)\|_2^2 + \lambda(t) \cdot \|\mathbf{L} \cdot \Phi_H(t)\|_2^2 \} \quad (2)$$

in which λ is the regularization parameter which controls the trade-off between the residual norm $\|\mathbf{A} \cdot \Phi_H(t) - \Phi_B(t)\|_2^2$ and the constraint norm $\|\mathbf{L} \cdot \Phi_H(t)\|_2^2$, and \mathbf{L} is a regularization matrix, which is equal to the identity matrix in zeroth-order Tikhonov regularization. For example, zeroth-order Tikhonov regularization provides a trade-off between a small amplitude and a small absolute error. Equation (2) is solved for $\hat{\Phi}_H(t)$ after determining an optimal λ .

Lastly, in ECGI, the torso as a volume conductor is often estimated to be homogeneous in terms of conductance. However, in real life, organs and tissues inside the torso lead to inhomogeneous conductivities. The estimation of the torso to be a homogeneous volume conductor leads to a problem which is less ill-posed and in practice does not yield results that are significantly worse than more complex piecewise-homogeneous torso volumes [11].

3.2 Physiological

The transfer matrix \mathbf{A} is commonly approximated to be static since the position of the heart and torso are typically captured with a CT or MRI scan during breath-hold and at the same timepoint within the cardiac phase. However, in reality, the geometry-conductivity relationship is dynamic. Firstly, the heart contracts, causing changes in its volume, position, and orientation. Secondly, variations in position and geometry of heart, lungs, and body surface are driven by inspiration and expiration. A preliminary study showed a small effect of the contractile motion of the heart on common outcome measures [12]. A recent computational study showed that cardiac motion due to breathing is non-negligible, thereby also proposing a geometrical correction method [13].

Secondly, the potential-based formulation of ECGI typically does not take the contribution of the septum and endocardial layers into account. Septal and endocardial information can be extracted from the body-surface ECG to a certain extent [14]. The most common

implementation of ECGI uses potentials measured on the body surface to estimate epicardial potentials only, and the physiological origin of enclosed underlying (i.e., transmural and/or septal) components is not separately considered in Equation (2). Even though this effect has never been actively studied to the best of the authors' knowledge, this could contribute to the inaccuracy of ECGI. Until then, the "epicardial-only"-reconstructed signals should probably be considered to be a mainly epicardial representation of the total transmural cardiac electrical activity.

3.3 Standardization

Lastly, since ECGI is currently being developed and being applied in different centers in parallel, methodologies in ECGI hardware and software can vary greatly. For example, the amount of electrodes used for ECGI can vary from 32 to 256, and electrodes can be either passive or active. Software-wise, researchers segment the heart differently [15] and use different source models [2]. Even within one source model, such as the potential-based formulation of ECGI which is treated in this article, different kinds of regularization, filtering, smoothing, and other parameters can be applied. Additionally, ECGI provides a large amount of multidimensional data, resulting in many possibilities for outcome measures that makes a comparison of studies or systems challenging. These differences in methodology also affect practical ease-of-use: e.g., a reduced number of electrodes is easier to apply but may be less accurate [16], and automated methods may be faster than ones requiring trained-operator input, but may also negatively impact reliability. Exploring different methodologies is paramount for identifying ECGI's potential, but it remains essential to realize that there is a large variety in implementation choices, which is why different (validation) studies yield different results. To achieve further maturation or clinical implementation, ECGI could benefit from the standardization of hardware and software.

3.4 Validation

Validation of ECGI can either be performed computationally, in a bucket or torso-shaped tank filled with fluid containing an ex-vivo heart, or in-vivo in either animals or humans. These validation methods are increasingly accurate in resembling a real-life situation at the cost of experimental complexity. Even in-vivo experiments may not completely mimic human application in a clinical setting. For example, in animal validation studies, the position of the heart and composition and size of the thorax can be different from humans. In human validation studies, the pericardium needs to be exposed to perform an invasive measurement. This means that ECGI can only either be validated in a non-time-aligned manner, or with a limited number of electrodes. Validation studies are discussed in more detail in the next section.

4 Validation studies

Even though ECGI’s technology comes with its intricacies, it still provides valuable information on cardiac electrical activity with a relatively high spatial accuracy. Since ECGI knows many implementations, we only describe ex-vivo and in-vivo experimental validation studies of the potential-based formulation of ECGI for the ventricles. Validation has been performed in many forms, through varying hardware setups, experimental setups and computational methods. For a more elaborate overview of different forms of validation, we refer to Cluitmans et al. [17]. Here, we discuss some key findings from various validation papers. An overview can be found in Table 1.

Table 1: Quantitative results of validation studies. Only quantitative results with one or more of our selected validation metrics were included. ECGI study results are shown relative to invasive mapping, the gold standard. Some studies are shown twice, since separate experiments were performed and not pooled. CC: correlation coefficient. LE: localization error. R: Pearson’s R. NTA: no time-aligned validation. D: Dog. H: Human. P: Pig. IQR: interquartile range. †: results of only healthy myocardium are shown. *: CC of only the T-wave, not the QRS complex.

Ref	Setup	Species (n)	Beats (n)	Electrogram CC	LE (mm)	AT R	RT R
[7]	Torso tank	D (1)		>0.9 for 72% of electrodes	<10		
[18]	In vivo (NTA)	H (3)	5	0.73	13		
[19]	Torso tank	D (1)	4	0.81	2		
[20]	In vivo	H (4)	79		13±9†		
[21]	In vivo	H (29)	456		9±6		
[21]	In vivo	H (5)	412		7±2		
[22]	In vivo	D (4)	93	0.71 [IQR 0.36-0.86]	10 [IQR 7-17]	0.82	0.73
[23]	In vivo (NTA)	H (55)	59		76±38	0.03±0.43	
[24]	Torso tank	P (8) and H (1)		0.85 [IQR 0.52-0.96]*			0.73 [IQR 0.63-0.83]
[24]	In vivo	P (5)		0.86 [IQR 0.52-0.96]*			0.76 [IQR 0.67-0.82]

As visible in Table 1, most studies have focused on the localization error of paced beats and on correlation coefficients (CCs) of the reconstructed epicardial electrograms. Fewer studies focused on activation or recovery times. Even though Bear et al. [24] reported no significant differences between torso tank and in vivo results for recovery, most in-vivo studies reported slightly lower accuracy than torso tank studies. Furthermore, results of most studies qualitatively agree, except for the study by Duchateau et al. [23], who found much poorer localization errors and activation time correlation than other studies. In this study, a commercial system was used. They reported that ECGI was much more accurate for paced rhythm than for sinus rhythm, and was prone to displaying artificial lines of slow conduction.

Even though this study did expose some of ECGI's important intricacies, other authors have warned that such a commercial implementation of ECGI without careful investigation of underlying electrograms and data should not be overgeneralized and requires further investigation [25], [26]. On the other hand, clinical applications should be based on commercially available systems and should be easy to use and accurate at the same time.

Apart from the study by Duchateau et al. [23], other studies show a reasonable performance of ECGI. Median pacing site localization errors vary from 2 to 13mm, and median correlations with invasive electrograms (CCs) differ from 0.71 to 0.86. ECGI's accuracy was reported to be lower on the left ventricular anterior side and during the QRS complex rather than during the T wave [22], the endocardial rather than the epicardial side [18], in scar rather than in viable tissue [20], outside rather than within the end-inspiratory phase [21], and during sinus rhythm rather than during paced rhythms [23] (even though a smaller study disagreed [18]). Of note, two studies showed that ECGI-reconstructed outcome measures may contain a spatial shift of 1-2 cm in relation to invasive electrograms [22,24], which could adversely affect validation outcomes that compare epicardial metrics node-by-node, while this spatial shift may not be important for most of ECGI's applications (e.g., detecting spatial gradients of activation or recovery isochrones or highlighting regions of interest).

Furthermore, several validation studies also assessed pacing site localization of endocardial origins, which can successfully be identified. Oster et al. [27] evaluated ECGI's performance in a torso tank containing a dog heart, by pacing from varying intramural depths. They reported epicardial breakthroughs occurring progressively later with deeper intramural pacing [27]. High-pass filtering of electrograms further aids in identifying the transmural origin of PVCs [28].

Lastly, Bear et al. [24] that ECGI is able to globally assess derivatives of recovery times, so-called repolarization gradients, which are considered to be important for arrhythmogenesis. These highly correlated with invasively measured repolarization gradients, despite the beforementioned slight spatial shift between ECGI and ground-truth recordings.

5 Applications and future directions

ECGI is currently widely used in a research setting but also increasingly to evaluate its clinical applicability [17]. ECGI has many applications, amongst which localizing the origin of premature ventricular contractions (PVCs), identification of accessory pathways from atria to ventricles, identification of atrial or ventricular fibrillation rotors, the optimization of cardiac resynchronization therapy (CRT), and arrhythmogenic substrate identification. Still, ECGI's clinical application is currently limited, considering that most applications would require more evidence of clinical benefits such as a better patient outcome or higher time-efficiency and cost-efficiency.

5.1 Premature ventricular contractions

Through activation time mapping or isopotential mapping, the origin of PVCs can be localized through ECGI with greater accuracy than a trained operator through clinical algorithms through the 12-lead ECG and to reduce procedural time in case of interventions [29].

5.2 Identification of fibrillation rotors

For atrial arrhythmias, ECGI is used to determine the mechanisms of the arrhythmia [30], though it remains challenging to correctly identify atrial fibrillation rotors [31]. In a recent clinical study, ECGI was used to successfully guide the targeting of persistent atrial fibrillation drivers [32]. ECGI is also used to identify mechanisms of ventricular fibrillation [17].

5.3 Optimizing cardiac resynchronization therapy

CRT is a therapy in which both ventricles are electrically paced to improve cardiac function in patients with heart failure and low ejection fraction. Due to the relative simple activation and recovery patterns that cardiac pacing produces compared to normal sinus rhythm, this is where ECGI's accuracy is highest [23]. For this reason, cardiac pacing and CRT seem to be ECGI's most promising applications. ECGI has been used to predict CRT outcomes, optimize CRT therapy, evaluate electrical dyssynchrony between the ventricles, and to optimize CRT lead placement [33].

5.4 Arrhythmogenic substrate identification

Lastly, ECGI allows the investigation of arrhythmogenic substrates and disease mechanisms in a novel and time-efficient manner. ECGI outcomes are often in line with hypotheses regarding the mechanisms of these diseases, such as premature and abnormal ventricular activation in the presence of an atrioventricular accessory pathway [34], increased repolarization gradients in long QT syndrome [35], conduction slowing and altered repolarization in the right ventricular outflow tract in Brugada syndrome compared to controls and more outspoken in mutation carriers [36–38], multiple abnormal repolarization properties in early repolarization syndrome [39], prolonged activation and recovery in arrhythmogenic right ventricular cardiomyopathy and correlation between ECGI parameters and MRI images [40], and increased activation time dispersion in hypertrophic cardiomyopathy [41].

Identifying subjects at risk for sudden cardiac death (SCD) remains the very challenging holy grail of ventricular electrophysiology. Identifying subjects at intermediate risk for SCD is challenging [42], particularly when routine clinical tools fail to identify any abnormality. Assessment of SCD risk is also challenging in relatives of affected individuals, who may carry genetic abnormalities. Several studies hint toward a promising role for ECGI for SCD risk stratification. For example, (unexplained) SCD survivors displayed an abnormal repolarization response to exercise [43]. A case in the Maastricht University Medical Center+

showed the same phenomenon, see Figure 4A. Furthermore, SCD survivors have shown to display increased activation time variability on ECGI after exercise, compared to non-SCD survivors [44]. Lastly, survivors of idiopathic ventricular fibrillation (SCD in patients without any substrate detectable by clinical tools) displayed distinct repolarization abnormalities through ECGI, in line with mechanistic studies [45], see Figure 4B. Generally, external validation and further evidence in the shape of prospective studies regarding the role of ECGI in risk stratification for SCD (e.g., by performing ECGI in family members of SCD survivors) is still required, but initial results seem promising.

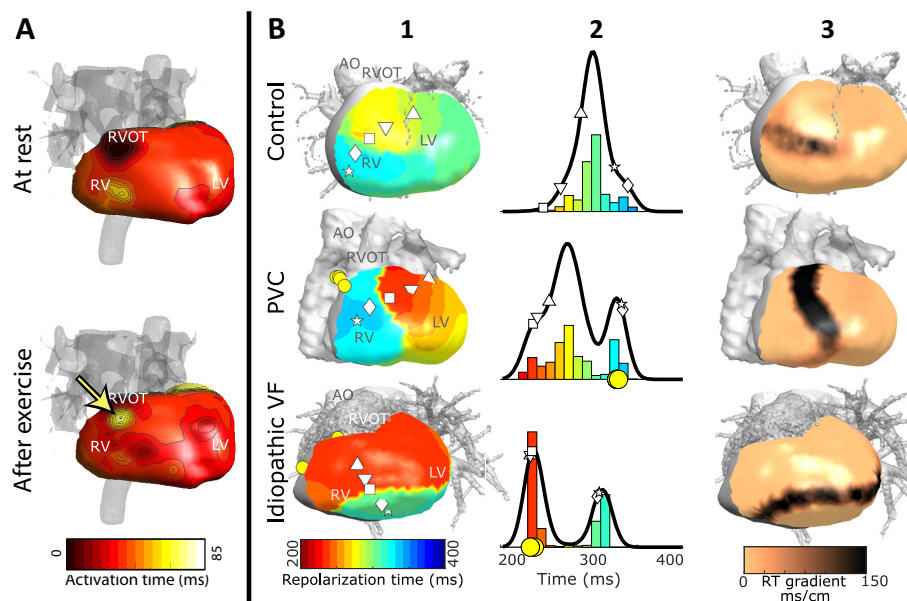

Figure 4: Arrhythmogenic substrate identification through ECGI. A: an SCD survivor showing an area of delayed activation after exercise which was not present during rest, analogous to [43]. B, adapted from [45] with permission: ECGI-derived repolarization maps of a control individual, a patient with frequent PVCs but without cardiac arrest, and an idiopathic ventricular fibrillation survivor. The latter showed two distinct repolarization areas separated by an increased repolarization gradient, whilst PVCs originated from the early-repolarizing area.

5.5 Multi-modality imaging

Several studies highlight ECGI's potential to be implemented in clinical care as a complementary modality. In complex patient cases, a singular modality cannot fully phenotype the arrhythmogenic substrate in a patient or guide therapy. ECGI's potential may lie in combining its electrical assessment with other (structural) modalities, potentially leading to improved electrostructural phenotyping of complex patients and personalized medicine, see Figure 5. For example, in combination with CT and MRI scans, ECGI has been demonstrated to guide lead implantation in patients requiring CRT [46] and to guide catheter ablation in

a case of ventricular tachycardia [47], see Figure 5A. In combination with functional and anatomical imaging, ECGI was used to guide catheter-free noninvasive radioablation for ventricular arrhythmias (see Figure 5B), after which arrhythmia burden was greatly reduced [48]. Conventional imaging provides information on tissue viability and scar, which is very useful to guide ablations. ECGI provides complementary electrical information which is vital to the working mechanisms of the arrhythmia.

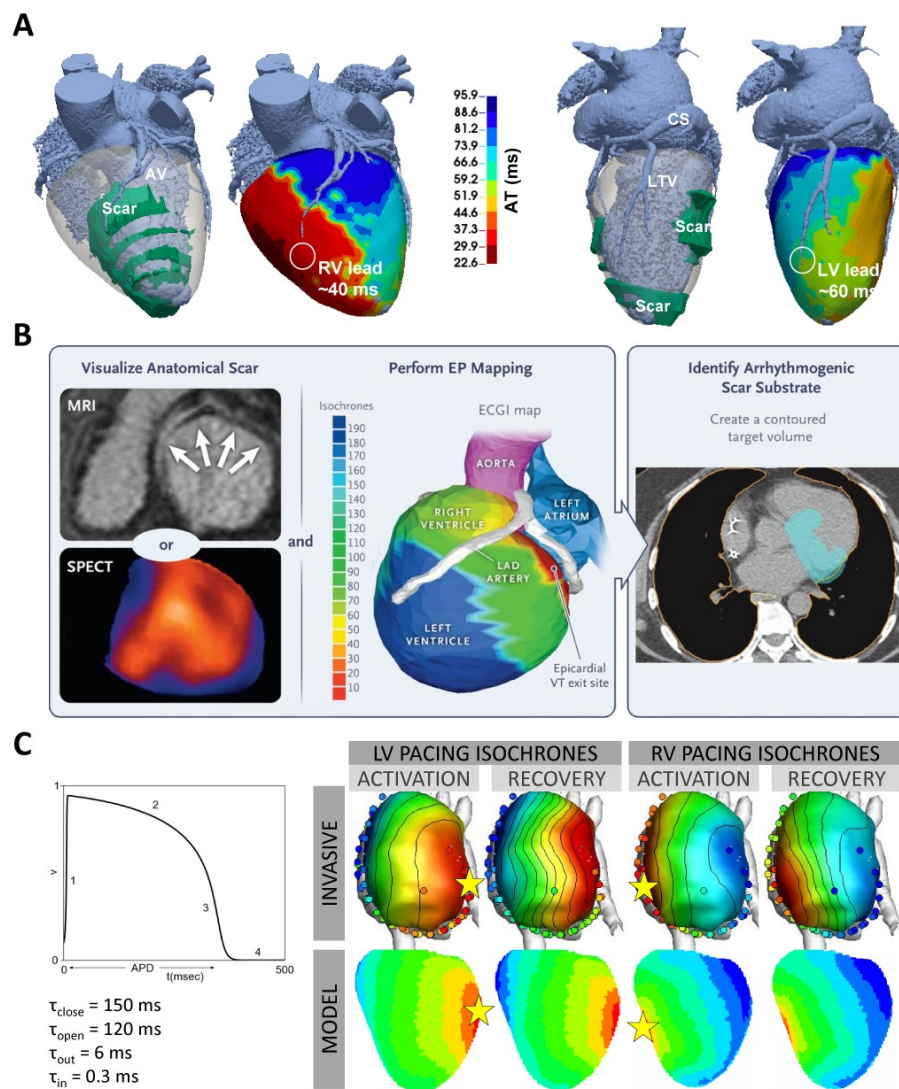

Figure 5: Image integration with ECGI. AV: anterior vein. RV: right ventricle. LV: left ventricle. CS: coronary sinus. LTV: lateral vein. LAD: left anterior descending. A, adapted from [46] with permission: optimizing lead placement in CRT by combining ECGI with MRI and CT scans. B, adapted from [48] with permission: Combining ECGI with anatomical imaging to guide catheter-free noninvasive cardiac radioablation for ventricular arrhythmias. C: Use of ECGI to personalize computational models to further perform risk stratification for SCD.

Lastly, the current progression of medical science is slowly shifting from a “one size fits most” towards personalized medicine: a “one size fits one” approach. Recent advances in computational modeling and machine learning have led to highly accurate predictions for future SCD or atrial fibrillation events using high-quality clinical data [49]. ECGI may be complementary to these techniques, providing further noninvasive personalization (see Figure 5C).

6 Conclusion

Almost 120 years after Einthoven made the first clinical ECG [50], conventional electrocardiography has been supplemented by ECGI, that was developed during the past 50 years. ECGI is a noninvasive modality to investigate cardiac electrical activity. Although challenges in ECGI exist, most validation studies show that ECGI can reconstruct cardiac electrical activity with moderate to good accuracy. Currently, ECGI is mostly used in a research setting, but for clinical implementation, further maturation is still required in terms of standardization, ease of use, and external validation of study results. Its ultimate clinical potential may lie not only in investigating disease mechanisms and providing risk stratification for future arrhythmic events, but most likely also in integrating ECGI with other clinical modalities for optimized personalized diagnosis and therapy guidance.

List of abbreviations

AV	Anterior vein
BSPM	Body surface potential map
CC	Correlation coefficient
CRT	Cardiac resynchronization therapy
CS	Coronary sinus
CT	Computed tomography
ECG	Electrocardiogram
ECGI	Electrocardiographic imaging
IQR	Interquartile range
LTV	Lateral vein
LV	Left ventricle
MRI	Magnetic resonance imaging
NTA	Not time aligned
PVC	Premature ventricular contraction
RV	Right ventricle
SCD	Sudden cardiac death

References

- [1] A.J. Pullan, L. K. Cheng, M.P. Nash, A. Ghodrati, R. MacLeod, and D.H. Brooks, “The Inverse Problem of Electrocardiography”, in: *Comprehensive Electrocardiology*, 2nd ed. London: Springer London, 2010, doi: http://dx.doi.org/10.1007/978-1-84882-046-3_9.
- [2] M.J.M. Cluitmans, R.L.M. Peeters, R.L. Westra, and P.G.A. Volders, “Noninvasive reconstruction of cardiac electrical activity: Update on current methods, applications and challenges,” *Netherlands Heart Journal*, vol. 23, no. 6, pp. 301–311, 2015, doi: <http://dx.doi.org/10.1007/s12471-015-0690-9>.
- [3] R.O. Martin and T.C. Pilkington, “Unconstrained Inverse Electrocardiography: Epicardial Potentials,” *IEEE Transactions on Biomedical Engineering*, vol. BME-19, no. 4, pp. 276–285, 1972, doi: <http://dx.doi.org/10.1109/TBME.1972.324070>.
- [4] R.O. Martin, T.C. Pilkington, and M.N. Morrow, “Statistically Constrained Inverse Electrocardiography,” *IEEE Transactions on Biomedical Engineering*, vol. BME-22, no. 6, pp. 487–492, 1975, doi: <http://dx.doi.org/10.1109/TBME.1975.324470>.
- [5] R.C. Barr and M.S. Spach, “Inverse calculation of QRS-T epicardial potentials from body surface potential distributions for normal and ectopic beats in the intact dog,” *Circulation Research*, vol. 42, no. 5, pp. 661–675, 1978, doi: <http://dx.doi.org/10.1161/01.RES.42.5.661>.
- [6] B.J. Messinger-Rapport and Y. Rudy, “Noninvasive recovery of epicardial potentials in a realistic heart-torso geometry. Normal sinus rhythm,” *Circulation Research*, vol. 66, no. 4, pp. 1023–1039, 1990, doi: <http://dx.doi.org/10.1161/01.RES.66.4.1023>.
- [7] H.S. Oster, B. Taccardi, R.L. Lux, P.R. Ershler, and Y. Rudy, “Noninvasive Electrocardiographic Imaging: reconstruction of epicardial potentials, electrograms, and isochrones and localization of single and multiple electrocardiac events,” *Circulation*, vol. 96, no. 3, pp. 1012–1024, Aug. 1997, doi: <http://dx.doi.org/10.1161/01.CIR.96.3.1012>.

- [8] C. Ramanathan, P. Jia, R. Ghanem, K. Ryu, and Y. Rudy,
“Activation and repolarization of the normal human heart under complete physiological conditions,”
Proceedings of the National Academy of Sciences, vol. 103, no. 16, pp. 6309–6314,
Apr. 2006,
doi: <http://dx.doi.org/10.1073/pnas.0601533103>.
- [9] J. Coll-Font, J. Dhamala, D. Potyagaylo, W.H.W. Schulze, J.D. Tate, M.S. Guillem, P. Van Dam, O. Dossel, D.H. Brooks, and R.S. Macleod,
“The consortium for electrocardiographic imaging,”
Computing in Cardiology, vol. 43, pp. 325–328, 2016,
doi: <http://dx.doi.org/10.22489/CinC.2016.094-431>.
- [10] A.N. Tikhonov, A.V. Goncharsky, V.V. Stepanov, and A.G. Yagola,
Numerical Methods for the Solution of Ill-Posed Problems,
Dordrecht: Springer Netherlands, 1995,
doi: <http://dx.doi.org/10.1007/978-94-015-8480-7>.
- [11] C. Ramanathan and Y. Rudy,
“Electrocardiographic imaging: I. Effect of torso inhomogeneities on body surface electrocardiographic potentials,”
Journal of Cardiovascular Electrophysiology, vol. 12, no. 2, pp. 229–240, 2001,
doi: <http://dx.doi.org/10.1046/j.1540-8167.2001.00229.x>.
- [12] J. Stoks, M.J.M. Cluitmans, R. Peeters, and P.G.A. Volders,
“The Influence of Using a Static Diastolic Geometry in ECG Imaging,”
Computing in Cardiology, vol. 46, pp. 2–5, 2019,
doi: <http://dx.doi.org/10.22489/CinC.2019.266>.
- [13] J.A. Bergquist, J. Coll-Font, B. Zenger, L.C. Rupp, W.W. Good, D.H. Brooks, and R.S. MacLeod,
“Reconstruction of cardiac position using body surface potentials,”
Computing in Biomedical Engineering, vol. 142, p. 105174, 2022,
doi: <http://dx.doi.org/10.1016/j.compbiomed.2021.105174>.
- [14] A. Berruezo, L. Mont, S. Nava, E. Chueca, E. Bartholomay, and J. Brugada,
“Electrocardiographic Recognition of the Epicardial Origin of Ventricular Tachycardias,”
Circulation, vol. 109, no. 15, pp. 1842–1847, 2004,
doi: <http://dx.doi.org/10.1161/01.CIR.0000125525.04081.4B>.

- [15] J.D. Tate, N. Zemzemi, W.W. Good, P. Van Dam, D.H. Brooks, and R.S. Macleod, “Effect of Segmentation Variation on ECG Imaging,” *Computing in Cardiology*, vol. 45, pp. 3–6, 2018, doi: <http://dx.doi.org/10.22489/CinC.2018.374>.
- [16] F.G. No, Y.S. Dogrusoz, O.N. Onak, and G.-W. Weber, “Reduced leadset selection and performance evaluation in the inverse problem of electrocardiography for reconstructing the ventricularly paced electrograms,” *Journal of Electrocardiology*, vol. 60, pp. 44–53, 2020, doi: <http://dx.doi.org/10.1016/j.jelectrocard.2020.02.017>.
- [17] M. Cluitmans, D.H. Brooks, R. MacLeod, O. Dössel, M.S. Guillem, P.M. Van Dam, J. Svehlikova, B. He, J. Sapp, L. Wang, et al., “Validation and opportunities of electrocardiographic imaging: From technical achievements to clinical applications,” *Frontiers in Physiology*, vol. 9, pp. 1–19, 2018, doi: <http://dx.doi.org/10.3389/fphys.2018.01305>.
- [18] R.N. Ghanem, P. Jia, C. Ramanathan, K. Ryu, A. Markowitz, and Y. Rudy, “Noninvasive electrocardiographic imaging (ECGI): Comparison to intraoperative mapping in patients,” *Heart Rhythm*, vol. 2, no. 4, pp. 339–354, 2005, doi: <http://dx.doi.org/10.1016/j.hrthm.2004.12.022>.
- [19] S. Ghosh and Y. Rudy, “Accuracy of quadratic versus linear interpolation in noninvasive electrocardiographic imaging (ECGI),” *Annals of Biomedical Engineering*, vol. 33, no. 9, pp. 1187–1201, 2005, doi: <http://dx.doi.org/10.1007/s10439-005-5537-x>.
- [20] J.L. Sapp, F. Dawoud, J.C. Clements, and B.M. Horáček, “Inverse solution mapping of epicardial potentials: Quantitative comparison with epicardial contact mapping,” *Circulation: Arrhythmia and Electrophysiology*, vol. 5, no. 5, pp. 1001–1009, 2012, doi: <http://dx.doi.org/10.1161/CIRCEP.111.970160>.
- [21] A.S. Revishvili, E. Wissner, D.S. Lebedev, C. Lemes, S. Deiss, A. Metzner, V.V. Kalinin, O.V. Sopov, E.Z. Labartkava, A.V. Kalinin, et al., “Validation of the mapping accuracy of a novel non-invasive epicardial and endocardial electrophysiology system,” *EP Europace*, vol. 17, no. 8, pp. 1282–1288, 2015, doi: <http://dx.doi.org/10.1093/europace/euu339>.

- [22] M.J.M. Cluitmans, P. Bonizzi, J.M.H. Karel, M. Das, B.L.J.H. Kietselaer, M.M.J. de Jong, F.W. Prinzen, R.L.M. Peeters, R.L. Westra, and P.G.A. Volders, “In Vivo Validation of Electrocardiographic Imaging,” *JACC: Clinical Electrophysiology*, vol. 3, no. 3, pp. 232–242, 2017, doi: <http://dx.doi.org/10.1016/j.jacep.2016.11.012>.
- [23] J. Duchateau, F. Sacher, T. Pambrun, N. Derval, J. Chamorro-Servent, A. Denis, S. Ploux, M. Hocini, P. Jaïs, O. Bernus, et al., “Performance and limitations of noninvasive cardiac activation mapping,” *Heart Rhythm*, vol. 16, no. 3, pp. 435–442, 2019, doi: <http://dx.doi.org/10.1016/j.hrthm.2018.10.010>.
- [24] L.R. Bear, M. Cluitmans, E. Abell, and J. Rogier, “Electrocardiographic Imaging of Repolarization Abnormalities,” *Journal of the American Heart Association*, vol. 10, no. 9, p. e020153, 2021, doi: <http://dx.doi.org/10.1161/JAHA.120.020153>.
- [25] Y. Rudy, “Letter to the Editor—ECG imaging and activation mapping,” *Heart Rhythm*, vol. 16, no. 6, pp. e50–e51, 2019, doi: <http://dx.doi.org/10.1016/j.hrthm.2019.02.001>.
- [26] M.J.M. Cluitmans, J. Stoks, and P.G.A. Volders, “To the Editor— Interpretation of electrograms is key to understand the clinical potential of ECGI,” *Heart Rhythm*, vol. 16, no. 6, pp. e51–e52, 2019, doi: <http://dx.doi.org/10.1016/j.hrthm.2019.02.030>.
- [27] H.S. Oster, B. Taccardi, R.L. Lux, P.R. Ershler, and Y. Rudy, “Electrocardiographic Imaging: Noninvasive Characterization of Intramural Myocardial Activation From Inverse-Reconstructed Epicardial Potentials and Electrograms,” *Circulation*, vol. 97, no. 15, pp. 1496–1507, 1998, doi: <http://dx.doi.org/10.1161/01.CIR.97.15.1496>.
- [28] P. Jurak, L.R. Bear, U.C. Nguyễn, I. Viscor, P. Andrla, F. Plesinger, J. Halamek, V. Vondra, E. Abell, M.J.M. Cluitmans, et al., “3-Dimensional ventricular electrical activation pattern assessed from a novel high-frequency electrocardiographic imaging technique: principles and clinical importance,” *Scientific Reports*, vol. 11, no. 1, pp. 1–11, 2021, doi: <http://dx.doi.org/10.1038/s41598-021-90963-4>.

- [29] D. Erkapic and T. Neumann,
“Ablation of premature ventricular complexes exclusively guided by three-dimensional noninvasive mapping,”
Cardiac Electrophysiology Clinics, vol. 7, no. 1, pp. 109–115, 2015,
doi: <http://dx.doi.org/10.1016/j.ccep.2014.11.010>.
- [30] J. Salinet, R. Molero, F.S. Schlindwein, J. Karel, M. Rodrigo, J.L. Rojo-Álvarez, O. Berenfeld, A.M. Climent, B. Zenger, F. Vanheusden, et al.,
“Electrocardiographic Imaging for Atrial Fibrillation: A Perspective From Computer Models and Animal Experiments to Clinical Value,”
Frontiers in Physiology, vol. 12, no. April, 2021,
doi: <http://dx.doi.org/10.3389/fphys.2021.653013>.
- [31] R. Vijayakumar, S.K. Vasireddi, P.S. Cuculich, M.N. Faddis, and Y. Rudy,
“Methodology Considerations in Phase Mapping of Human Cardiac Arrhythmias,”
Circulation: Arrhythmia and Electrophysiology, vol. 9, no. 11, Nov. 2016,
doi: <http://dx.doi.org/10.1161/CIRCEP.116.004409>.
- [32] S. Honarbakhsh, G. Dhillon, H. Abbass, P.H. Waddingham, A. Dennis, N. Ahluwalia, S. Welch, H. Daw, S. Sporton, A. Chow, et al.,
“Noninvasive electrocardiographic imaging–guided targeting of drivers of persistent atrial fibrillation: The TARGET-AF1 trial,”
Heart Rhythm, vol. 19, no. 6, pp. 875–884, 2022,
doi: <http://dx.doi.org/10.1016/j.hrthm.2022.01.042>.
- [33] K. Sedova, K. Repin, G. Donin, P. Van Dam, and J. Kautzner,
“Clinical utility of body surface potential mapping in CRT patients,”
Arrhythmia & Electrophysiology Review, vol. 10, no. 2, pp. 113–119, 2021,
doi: <http://dx.doi.org/10.15420/aer.2021.14>.
- [34] S. Ghosh, E.K. Rhee, J.N. Avari, P.K. Woordard, and Y. Rudy,
“Cardiac Memory in WPW Patients: Noninvasive Imaging of Activation and Repolarization Before and After Catheter Ablation,”
Circulation, vol. 118, no. 9, pp. 907–915, 2008,
doi: <http://dx.doi.org/10.1161/CIRCULATIONAHA.108.781658>.

- [35] R. Vijayakumar, J.N.A. Silva, K.A. Desouza, R.L. Abraham, M. Strom, F. Sacher, G.F. Van Hare, M. Haïssaguerre, D.M. Roden, and Y. Rudy, “Electrophysiologic substrate in congenital long QT syndrome: Noninvasive mapping with electrocardiographic imaging (ECGI),” *Circulation*, vol. 130, no. 22, pp. 1936–1943, 2014, doi: <http://dx.doi.org/10.1161/CIRCULATIONAHA.114.011359>.
- [36] J. Zhang, F. Sacher, K. Hoffmayer, T. O’Hara, M. Strom, P. Cuculich, J. Silva, D. Cooper, M. Faddis, M. Hocini, et al., “Cardiac electrophysiological substrate underlying the ECG phenotype and electrogram abnormalities in brugada syndrome patients,” *Circulation*, vol. 131, no. 22, pp. 1950–1959, 2015, doi: <http://dx.doi.org/10.1161/CIRCULATIONAHA.114.013698>.
- [37] K.M.W. Leong, F.S. Ng, C. Yao, C. Roney, P. Taraborrelli, N.W.F. Linton, Z.I. Whinnett, D.C. Lefroy, D.W. Davies, P. Boon Lim, et al., “ST-elevation magnitude correlates with right ventricular outflow tract conduction delay in Type I Brugada ECG,” *Circulation: Arrhythmia and Electrophysiology*, vol. 10, no. 10, pp. 1–12, 2017, doi: <http://dx.doi.org/10.1161/CIRCEP.117.005107>.
- [38] L. Pannone, C. Monaco, A. Sorgente, P. Vergara, A. Gauthey, P.A. Calborean, A. Bisignani, G. Paparella, R. Ramak, I. Overeinder, et al., “SCN5A mutation in Brugada syndrome is associated with substrate severity detected by electrocardiographic imaging and high-density electroanatomic mapping,” *Heart Rhythm*, vol. 19, no. 6, pp. 945–951, 2022, doi: <http://dx.doi.org/10.1016/j.hrthm.2022.01.034>.
- [39] J. Zhang, M. Hocini, M. Strom, P.S. Cuculich, D.H. Cooper, F. Sacher, M. Haïssaguerre, and Y. Rudy, “The Electrophysiological Substrate of Early Repolarization Syndrome: Noninvasive Mapping in Patients,” *JACC: Clinical Electrophysiology*, vol. 3, no. 8, pp. 894–904, 2017, doi: <http://dx.doi.org/10.1016/j.jacep.2016.12.017>.

- [40] C.M. Andrews, N.T. Srinivasan, S. Rosmini, H. Bulluck, M. Orini, S. Jenkins, A. Pantazis, W.J. McKenna, J.C. Moon, P.D. Lambiase, et al.,
“Electrical and Structural Substrate of Arrhythmogenic Right Ventricular Cardiomyopathy Determined Using Noninvasive Electrocardiographic Imaging and Late Gadolinium Magnetic Resonance Imaging,”
Circulation: Arrhythmia and Electrophysiology, vol. 10, no. 7, pp. 1–12, 2017,
doi: <http://dx.doi.org/10.1161/CIRCEP.116.005105>.
- [41] E.A. Perez-Alday, K.T. Haq, D.M. German, C. Hamilton, K. Johnson, F. Phan, N.M. Rogovoy, K. Yang, A. Wirth, J.A. Thomas, et al.,
“Mechanisms of Arrhythmogenicity in Hypertrophic Cardiomyopathy: Insight From Non-invasive Electrocardiographic Imaging,”
Frontiers in Physiology, vol. 11, 24 April, 2020,
doi: <http://dx.doi.org/10.3389/fphys.2020.00344>.
- [42] S.G. Priori, C. Blomstrom-Lundqvist, A. Mazzanti, N. Bloma, M. Borggrefe, J. Camm, P.M. Elliott, D. Fitzsimons, R. Hatala, G. Hindricks, et al.,
“2015 ESC Guidelines for the management of patients with ventricular arrhythmias and the prevention of sudden cardiac death the Task Force for the Management of Patients with Ventricular Arrhythmias and the Prevention of Sudden Cardiac Death of the Europea,”
European Heart Journal, vol. 36, no. 41, pp. 2793-2867, 2015,
doi: <http://dx.doi.org/10.1093/eurheartj/ehv316>.
- [43] K.M.W. Leong, F.S. Ng, C. Roney, C. Cantwell, M.J. Shun-Shin, N.W.F. Linton, Z.I. Whinnett, D.C. Lefroy, D.W. Davies, S.E. Harding, et al.,
“Repolarization abnormalities unmasked with exercise in sudden cardiac death survivors with structurally normal hearts,”
Journal of Cardiovascular Electrophysiology, vol. 29, no. 1, pp. 115–126, Jan. 2018,
doi: <http://dx.doi.org/10.1111/jce.13375>.
- [44] K.M.W. Leong, F.S. Ng, M.J. Shun-Shin, M. Koa-Wing, N. Qureshi, Z.I. Whinnett, N.F. Linton, D. Lefroy, D.P. Francis, S.E. Harding, et al.,
“Non-invasive detection of exercise-induced cardiac conduction abnormalities in sudden cardiac death survivors in the inherited cardiac conditions,”
EP Europace, vol. 23, no. 2, pp. 305–312, 2021,
doi: <http://dx.doi.org/10.1093/europace/euaa248>.

- [45] M.J.M. Cluitmans, L.R. Bear, U.C. Nguyễn, B. van Rees, J. Stoks, R.M.A. ter Bekke, C. Muhl, J. Heijman, K.D. Lau, E. Vigmond, et al.,
“Noninvasive detection of spatiotemporal activation-repolarization interactions that prime idiopathic ventricular fibrillation,”
Science Translational Medicine, vol. 13, no. 620, eabi9317, 2021,
doi: <http://dx.doi.org/10.1126/scitranslmed.abi9317>.
- [46] U.C. Nguyễn, M.J.M. Cluitmans, M. Strik, J.G. Luermans, S. Gommers, J.E. Wildberger, S.C.A.M. Bekkers, P.G.A. Volders, C. Muhl, F.W. Prinzen, et al.,
“Integration of cardiac magnetic resonance imaging, electrocardiographic imaging, and coronary venous computed tomography angiography for guidance of left ventricular lead positioning,”
EP Europace, vol. 21, no. 4, pp. 626–635, 2019,
doi: <http://dx.doi.org/10.1093/europace/euy292>.
- [47] D.Nguyen, J.Jeudy, A.J. Restrepo, and T.M. Dickfeld,
“A Novel Use of Noninvasive Registered Electrocardiographic Imaging Map for Localization of VT and PVC,”
JACC: Case Reports, vol. 3, no. 4, pp. 591–593, 2021,
doi: <http://dx.doi.org/10.1016/j.jaccas.2021.01.031>.
- [48] P.S. Cuculich, M.R. Schill, R. Kashani, S. Mutic, A. Lang, D. Cooper, M. Faddis, M. Gleva, A. Noheria, T.W. Smith, et al.,
“Noninvasive Cardiac Radiation for Ablation of Ventricular Tachycardia,”
New England Journal of Medicine, vol. 377, no. 24, pp. 2325–2336, 2017,
doi: <http://dx.doi.org/10.1056/nejmoa1613773>.
- [49] N.A. Trayanova, D.M. Popescu, and J.K. Shade,
“Machine Learning in Arrhythmia and Electrophysiology,”
Circulation Research, vol. 128, no. 4, pp. 544–566, 2021,
doi: <http://dx.doi.org/10.1161/CIRCRESAHA.120.317872>.
- [50] W. Einthoven,
“Le télécardiogramme”,
Archives Internationales de Physiologie, vol. 4 (sept./a2), pp. 132-164, 1906.

IEEE Milestone Award “String Galvanometer”

The Heritage and the Promise of Electrocardiography and Electrophysiology

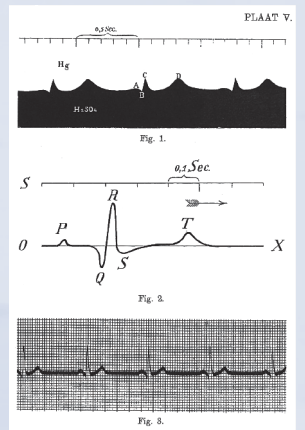
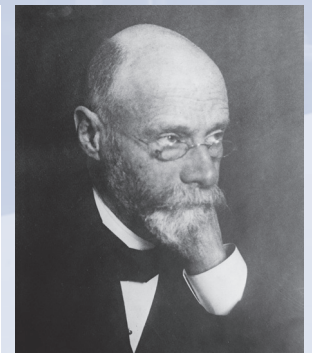
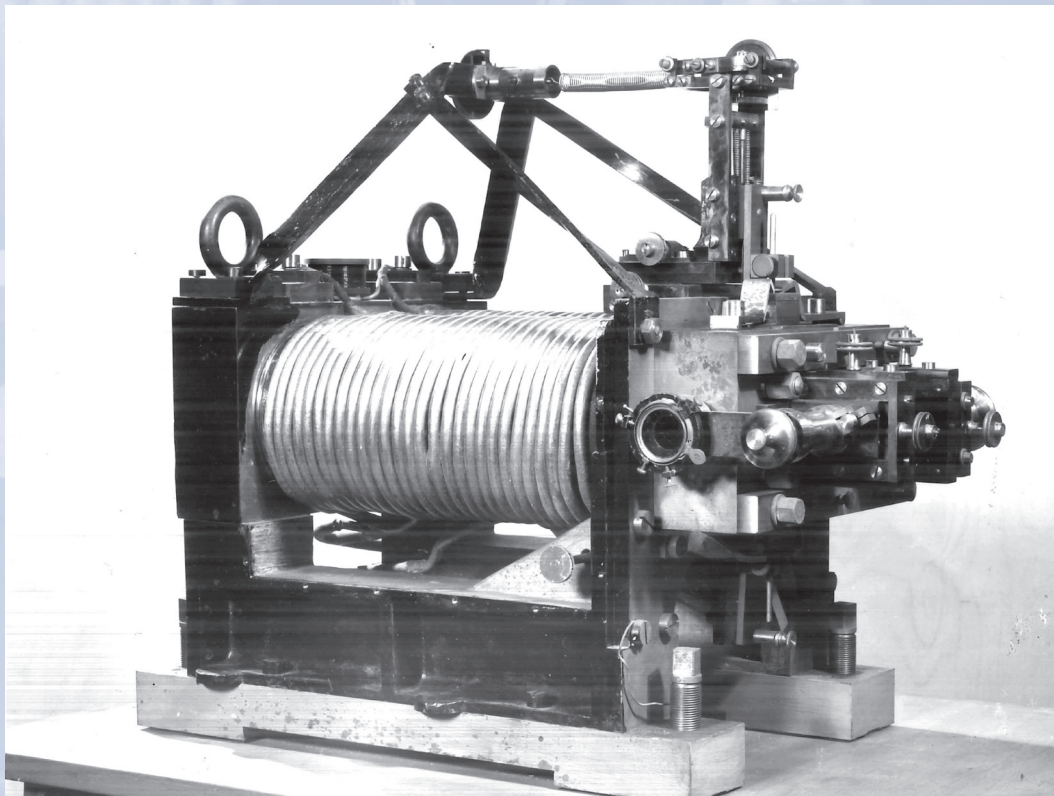

Willem Einthoven, his string galvanometer, and the figures (“Plaat V”) from his 1902 publication that show the improvement in ECG signal quality of the string galvanometer (Fig. 3) compared to the then existing method (Fig. 1).